

ORF307 – Optimization

20. Integer optimization

Announcements

- Last precepts next week
- Last homework out Thursday next week

Today's lecture

Mixed-integer optimization

- Mixed-integer programs
- Modeling techniques
- Formulations
- Ideal formulations

Mixed-integer optimization

Mixed-integer program

Optimization problem where some variables are restricted to be integer

$$\begin{array}{ll} \text{minimize} & c^T x \\ \text{subject to} & Ax \leq b \\ & x_i \in \mathbf{Z}, \quad i \in \mathcal{I} \end{array}$$

Mixed-integer program

Optimization problem where some variables are restricted to be integer

minimize $c^T x$

subject to $Ax \leq b$

$x_i \in \mathbf{Z}, \quad i \in \mathcal{I}$

Mixed-integer program

Optimization problem where some variables are restricted to be integer

$$\begin{array}{ll} \text{minimize} & c^T x \\ \text{subject to} & Ax \leq b \\ & x_i \in \mathbf{Z}, \quad i \in \mathcal{I} \end{array}$$

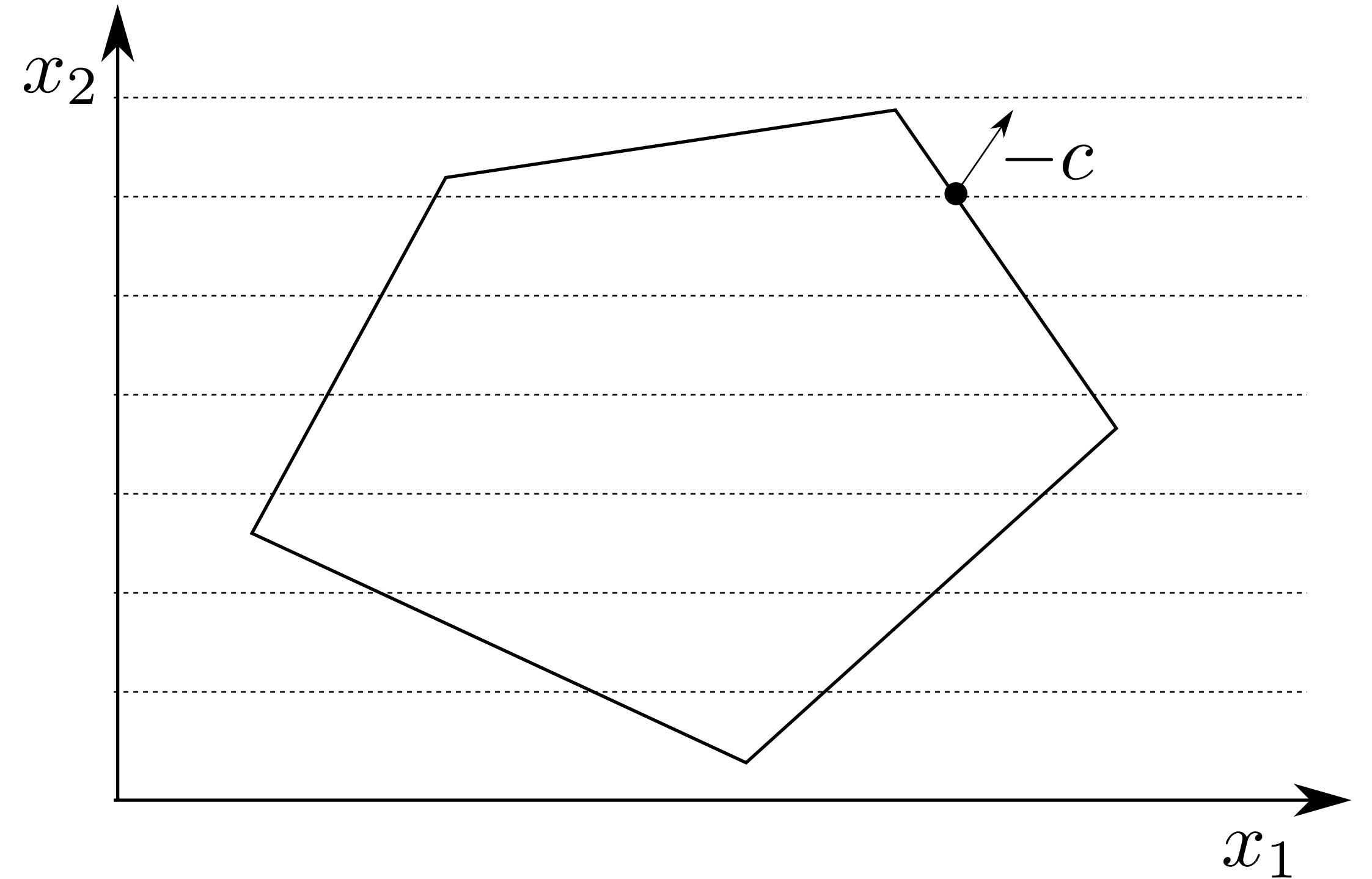

Mixed-integer program

Special cases

Integer linear program

$$\mathcal{I} = \{1, \dots, n\}$$

(all variables are integer)

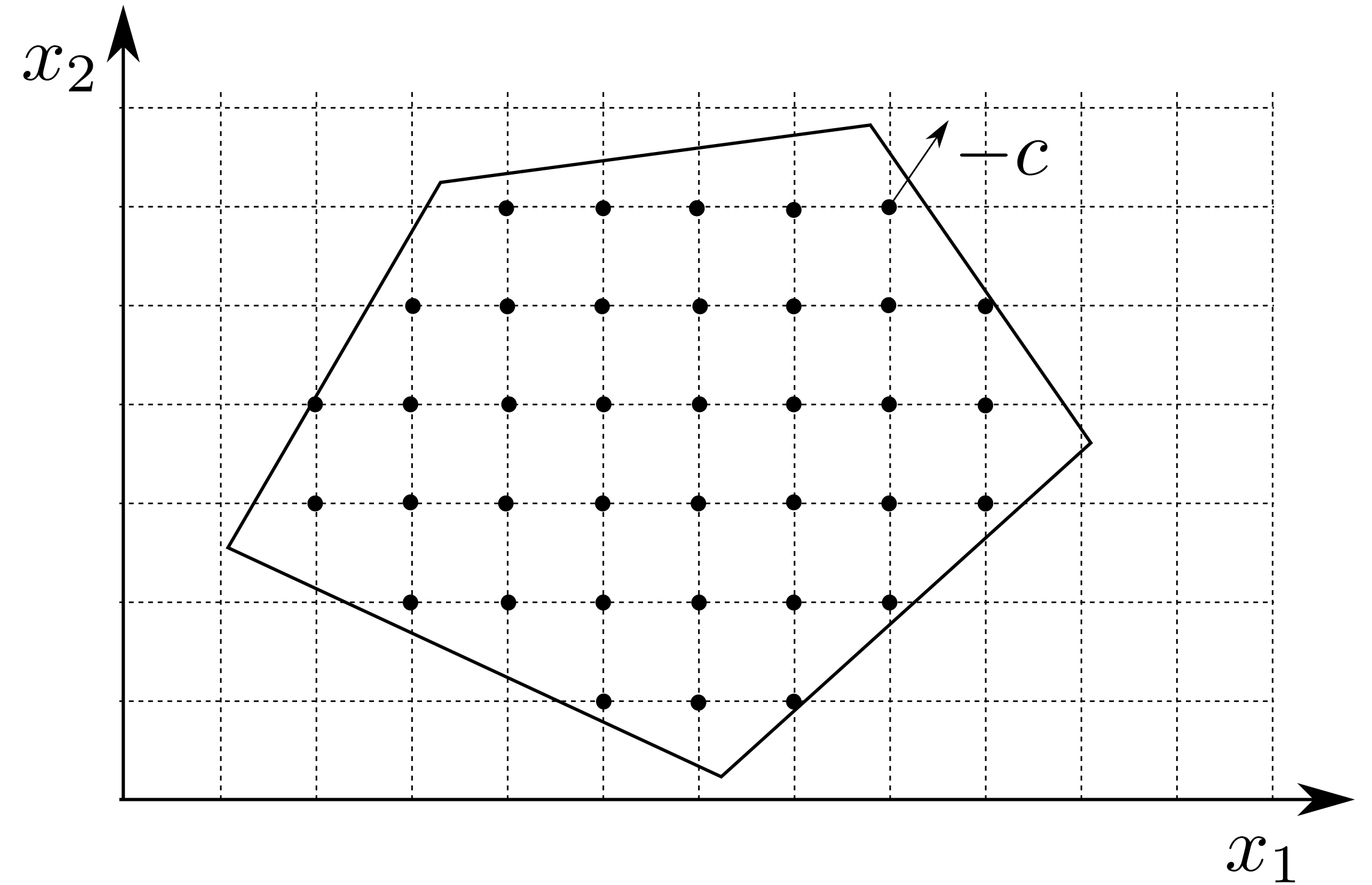

Mixed-integer program

Special cases

Integer linear program

$$\mathcal{I} = \{1, \dots, n\}$$

(all variables are integer)

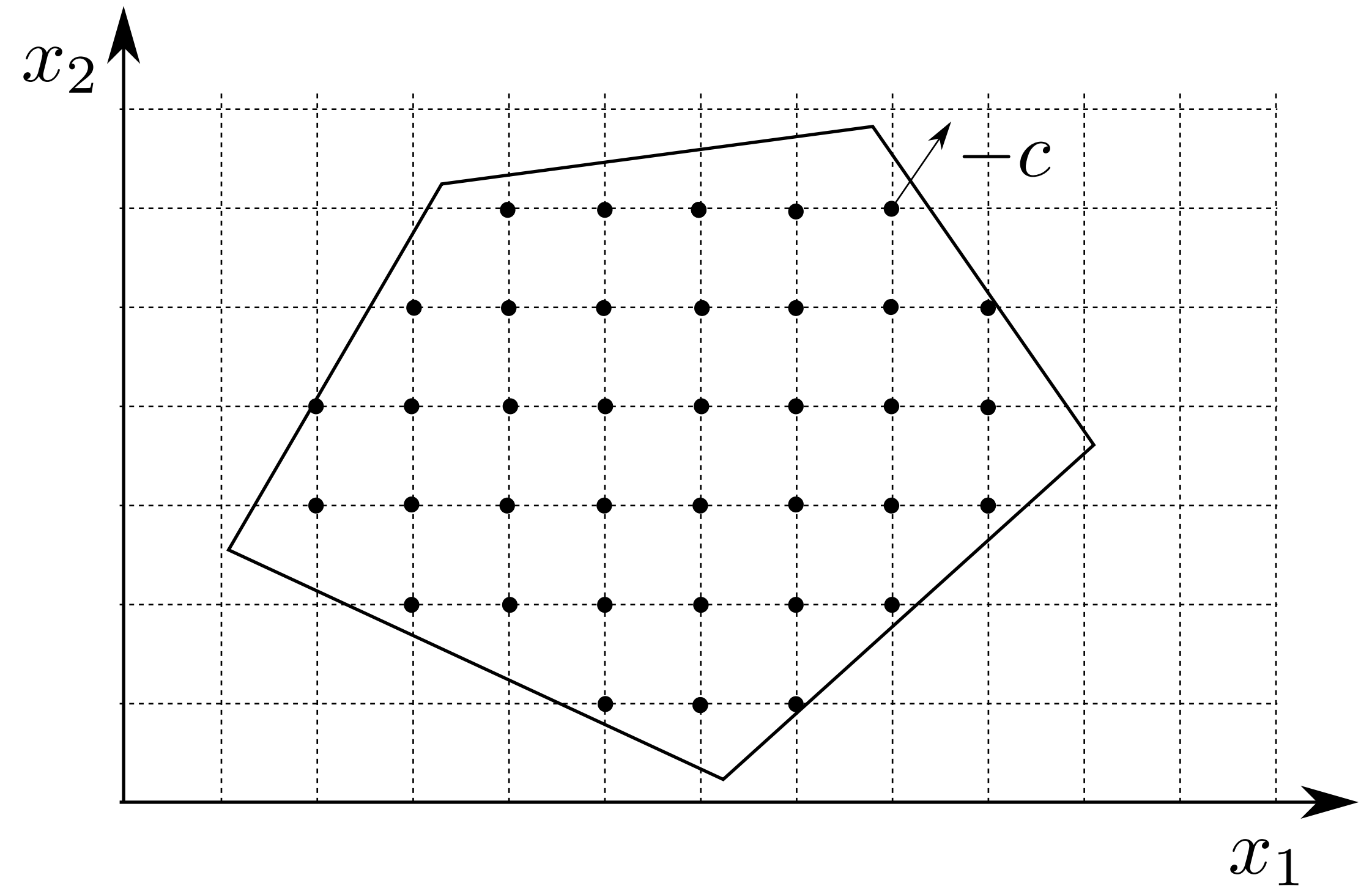

Boolean linear program

$$x_i \in \{0, 1\}, \quad i \in \mathcal{I}$$

(integer variables take values 0 or 1)

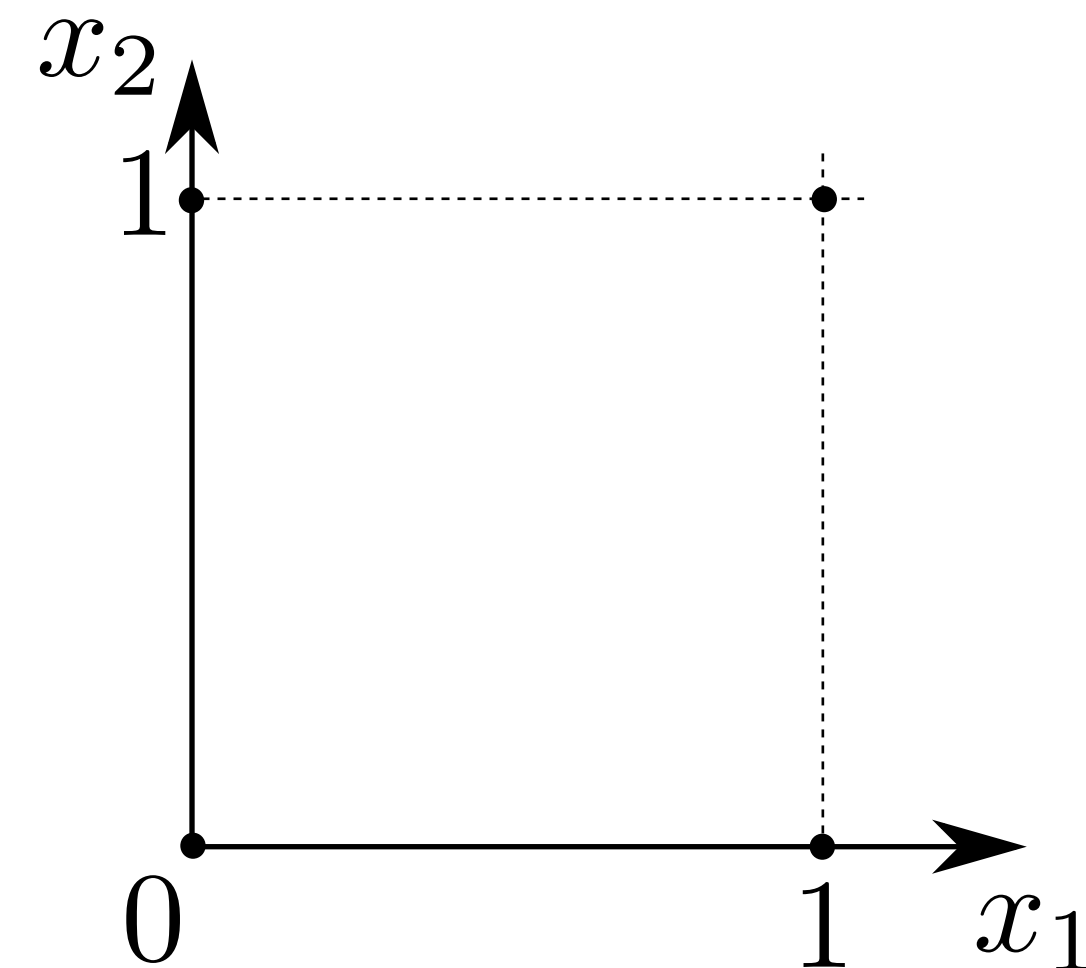

Modeling techniques

Binary choice

$$x \in \{0,1\} \times \{0,1\} \times \dots$$

$$x_i = \begin{cases} 1 & \text{event occurs} \\ 0 & \text{otherwise} \end{cases} \longrightarrow x \in \{0,1\}^n$$

$$x_i \in \{0,1\} \\ i = 1, \dots, n$$

Examples

- Perform an financial transaction
- Select an arc in a graph
- Open a store

Knapsack problem



Goal decide between n items to put into knapsack

- Maximum total weight: b
- Weight of item i : a_i
- Value of item i : c_i

Formulation

maximize $c^T x$

subject to $a^T x \leq b$

$x_i \in \{0, 1\}, \quad i = 1, \dots, n$

$$a^T x = \sum_{i=1}^n a_i x_i$$

Logical relations

$$x \in \{0, 1\}^n$$

At most one event occurs

$$\mathbf{1}^T x \leq 1$$

Logical relations

$$x \in \{0, 1\}^n$$

At most one event occurs

$$\mathbf{1}^T x \leq 1$$

Neither or both events occur

$$x_1 = x_2$$

Logical relations

$$x \in \{0, 1\}^n$$

At most one event occurs

$$\mathbf{1}^T x \leq 1$$

Neither or both events occur

$$x_1 = x_2$$

If $x_2 = 0$ (does not occur), then $x_1 = 0$ (does not occur)

$$x_1 \leq x_2$$

Facility location problem

Data

- n potential facility locations, m clients
- c_j cost of opening facility at location j
- d_{ij} cost of serving client i from location j

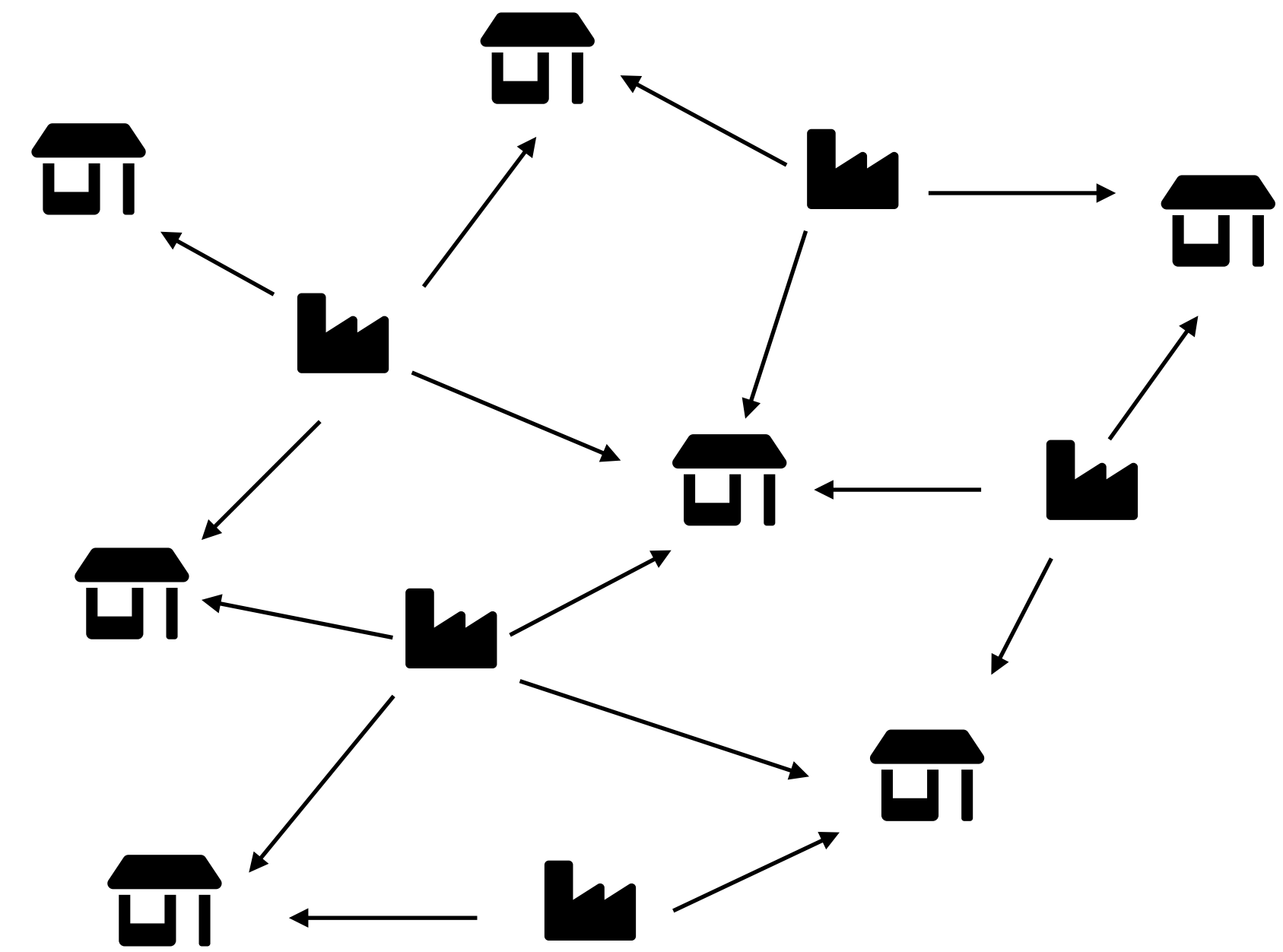

Facility location problem

Data

- n potential facility locations, m clients
- c_j cost of opening facility at location j
- d_{ij} cost of serving client i from location j

Variables

$$y_j = \begin{cases} 1 & \text{location } j \text{ is selected} \\ 0 & \text{otherwise} \end{cases}$$

$$x_{ij} = \begin{cases} 1 & \text{location } j \text{ serves client } i \\ 0 & \text{otherwise} \end{cases}$$

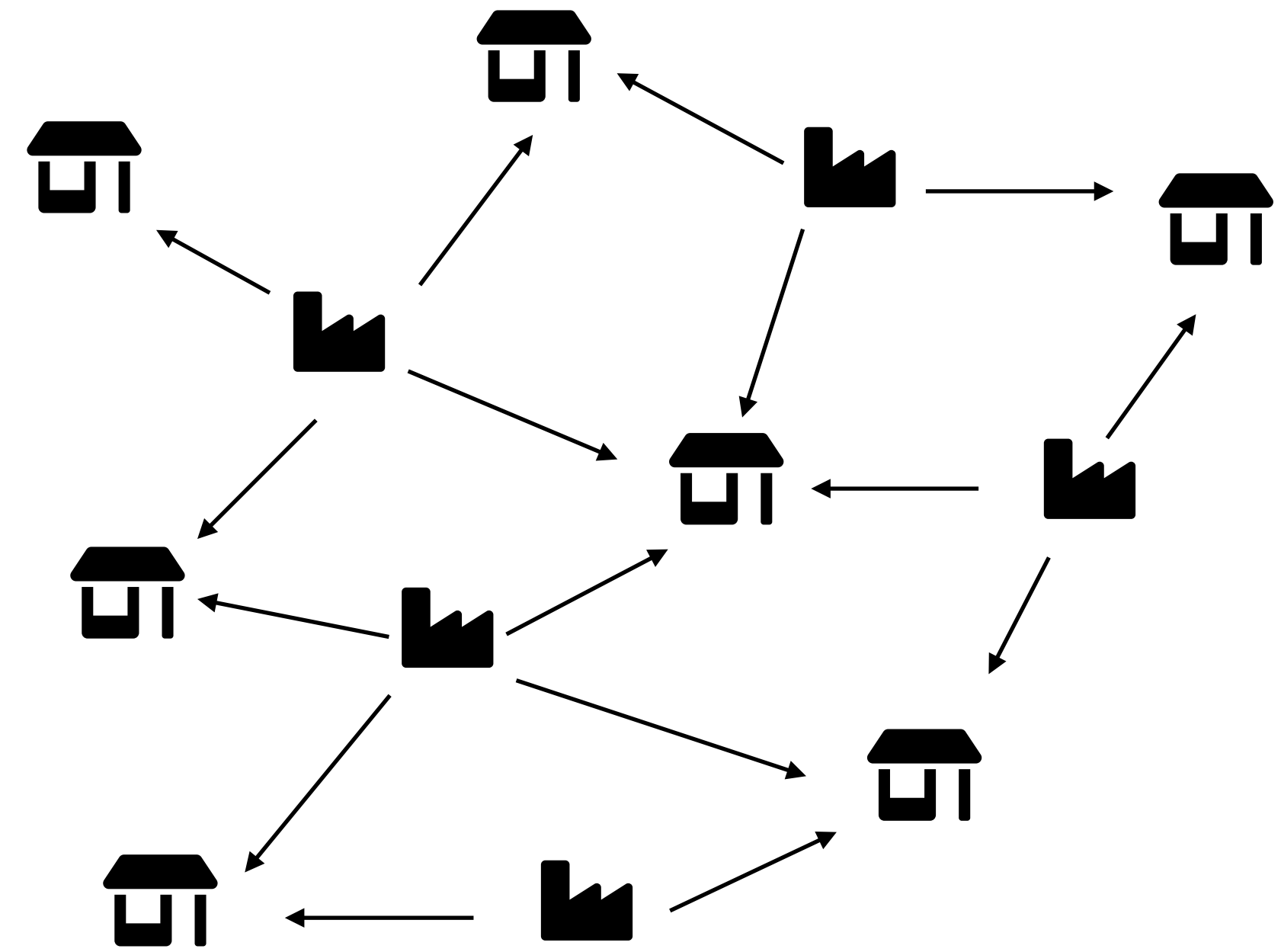

Facility location problem

Data

- n potential facility locations, m clients
- c_j cost of opening facility at location j
- d_{ij} cost of serving client i from location j

Variables

$$y_j = \begin{cases} 1 & \text{location } j \text{ is selected} \\ 0 & \text{otherwise} \end{cases}$$

$$x_{ij} = \begin{cases} 1 & \text{location } j \text{ serves client } i \\ 0 & \text{otherwise} \end{cases}$$

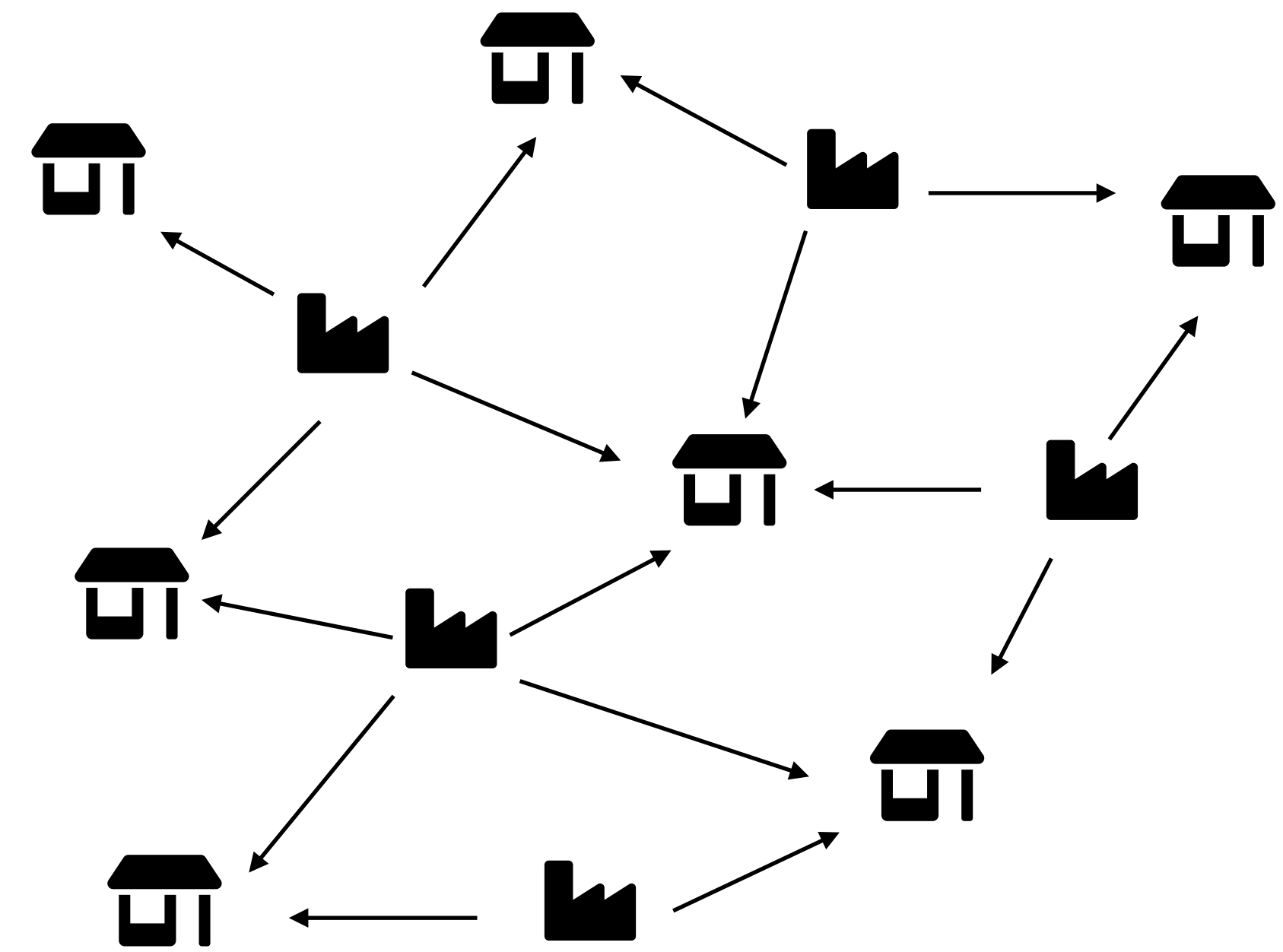

Problem

minimize $\underbrace{\sum_{j=1}^n c_j y_j}_{\text{COST OF OPENING}} + \underbrace{\sum_{i=1}^m \sum_{j=1}^n d_{ij} x_{ij}}_{\text{COST OF SERVING CLIENTS}}$

subject to $\sum_{j=1}^n x_{ij} = 1, \quad i = 1, \dots, m$

$$x_{ij} \leq y_j, \quad i = 1, \dots, m, \quad j = 1, \dots, n$$

$$x_{ij}, y_j \in \{0, 1\}$$

$$\sum_{i=1}^m x_{ij} \leq y_j$$

$$j = 1, \dots, n$$

Mixed-logical relations (big-M formulations)

$$x \in \mathbf{R}, y \in \{0, 1\}$$

If $y = 0$, then $x = 0$. Otherwise, x unconstrained. (≥ 0)

$$0 \leq x \leq yM$$

Very LARGE CONSTANT (big-M)

Mixed-logical relations (big-M formulations)

$$x \in \mathbf{R}, y \in \{0, 1\}$$

If $y = 0$, then $x = 0$. Otherwise, x unconstrained.

$$0 \leq x \leq yM$$

Disjunctive constraints

either $a^T x \leq b$ or $d^T x \leq f$ is valid

$$\begin{cases} a^T x \leq b + yM \\ d^T x \leq f + (1 - y)M \end{cases}$$

$$\begin{aligned} y=1 &\Rightarrow \begin{cases} a^T x \leq b + M & (\text{REDUNDANT}) \\ d^T x \leq f \end{cases} \\ y=0 &\Rightarrow \begin{cases} a^T x \leq b \\ d^T x \leq f + M & (\text{REDUNDANT}) \end{cases} \end{aligned}$$

Cardinality

$$x \in \mathbf{R}^n, y \in \{0, 1\}^n$$

Cardinality (0-norm)

number of nonzero elements

$$\text{card } x = \|x\|_0 = \sum \{i \mid x_i \neq 0\}$$

Cardinality constraint

$$\text{card } x \leq k$$



$$\sum_{i=1}^m y_i \leq k$$

$$-My_i \leq x_i \leq My_i, \quad i = 1, \dots, n$$

$$y_i \in \{0, 1\}$$

Restricted range of values

We want to restrict variable $x \in \mathbb{R}$ to take values $\{a_1, \dots, a_d\}$

Restricted range of values

We want to restrict variable $x \in \mathbb{R}$ to take values $\{a_1, \dots, a_d\}$

Introduce d binary variables $z_i \in \{0, 1\}$

$$x = \sum_{j=1}^d a_j z_j$$

$$\sum_{j=1}^d z_j = 1$$

$$z_j \in \{0, 1\}$$

Restricted range of values

We want to restrict variable $x \in \mathbb{R}$ to take values $\{a_1, \dots, a_d\}$

Introduce d binary variables $z_i \in \{0, 1\}$

$$x = \sum_{j=1}^d a_j z_j$$

$$\sum_{j=1}^d z_j = 1$$

$$z_j \in \{0, 1\}$$



Vector form

$$x = a^T z$$

$$\mathbf{1}^T z = 1$$

$$z \in \{0, 1\}^d$$

Signal decoding

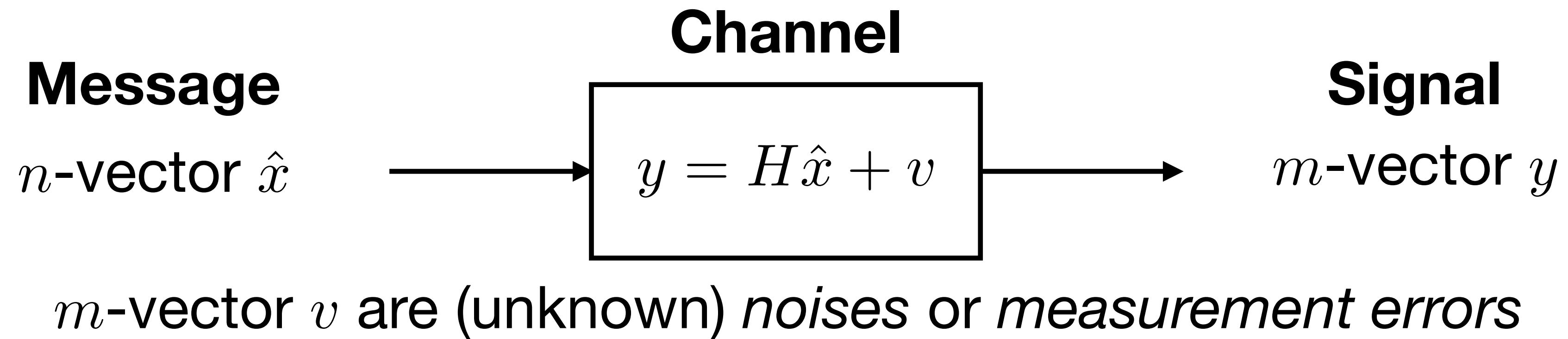

Goal recover message \hat{x}

Signal decoding

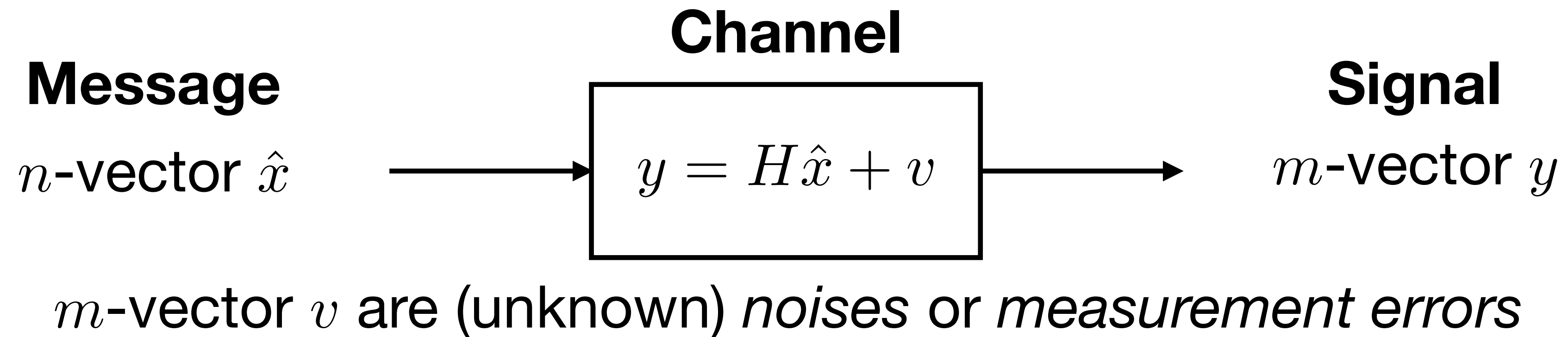

Goal recover message \hat{x}

Signal constellation

At every time k , x_k can take only values $\{a_1, \dots, a_d\}$

Signal decoding

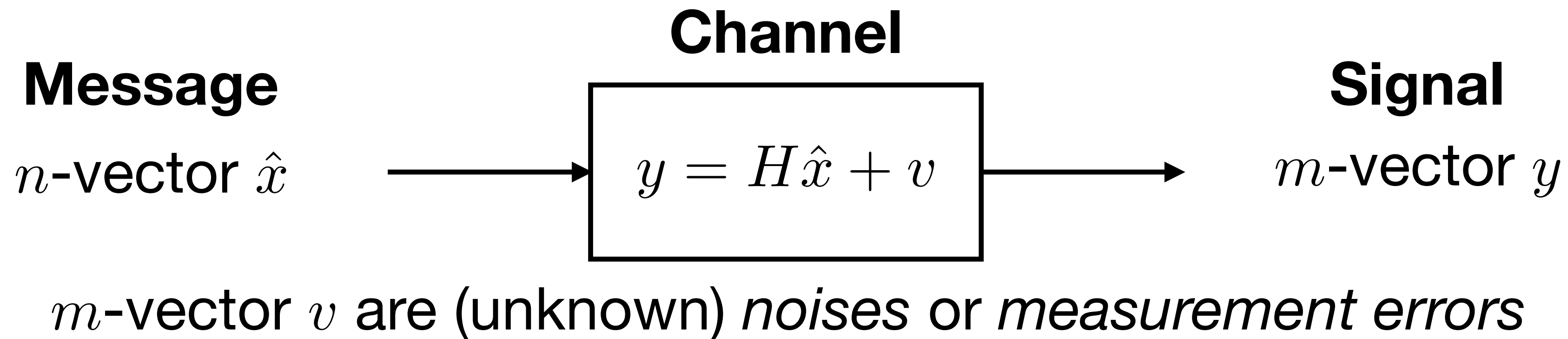

Goal recover message \hat{x}

Signal constellation

At every time k , x_k can take only values $\{a_1, \dots, a_d\}$

Signal decoding problem

minimize $\|Hx - y\|_1$
subject to $x_k \in \{a_1, \dots, a_d\}, \quad k = 1, \dots, n$

Signal decoding as mixed-integer optimization

Signal decoding problem

$$\begin{aligned} &\text{minimize} && \|Hx - y\|_1 \\ &\text{subject to} && x_k \in \{a_1, \dots, a_d\}, \quad k = 1, \dots, n \end{aligned}$$

Mixed-integer optimization

$$\begin{aligned} &\text{minimize} && \mathbf{1}^T u \\ &\text{subject to} && -u \leq Hx - y \leq u \\ &&& x_k = a^T z_k, \quad k = 1, \dots, n \\ &&& \mathbf{1}^T z_k = 1, \quad k = 1, \dots, n \\ &&& z_k \in \{0, 1\}^d \end{aligned}$$

Signal decoding example

Exact message $\hat{x} \in \{-3, -1, 1, 3\}^{40}$

Noisy signal $y = H\hat{x} + v \in \mathbf{R}^{200}$

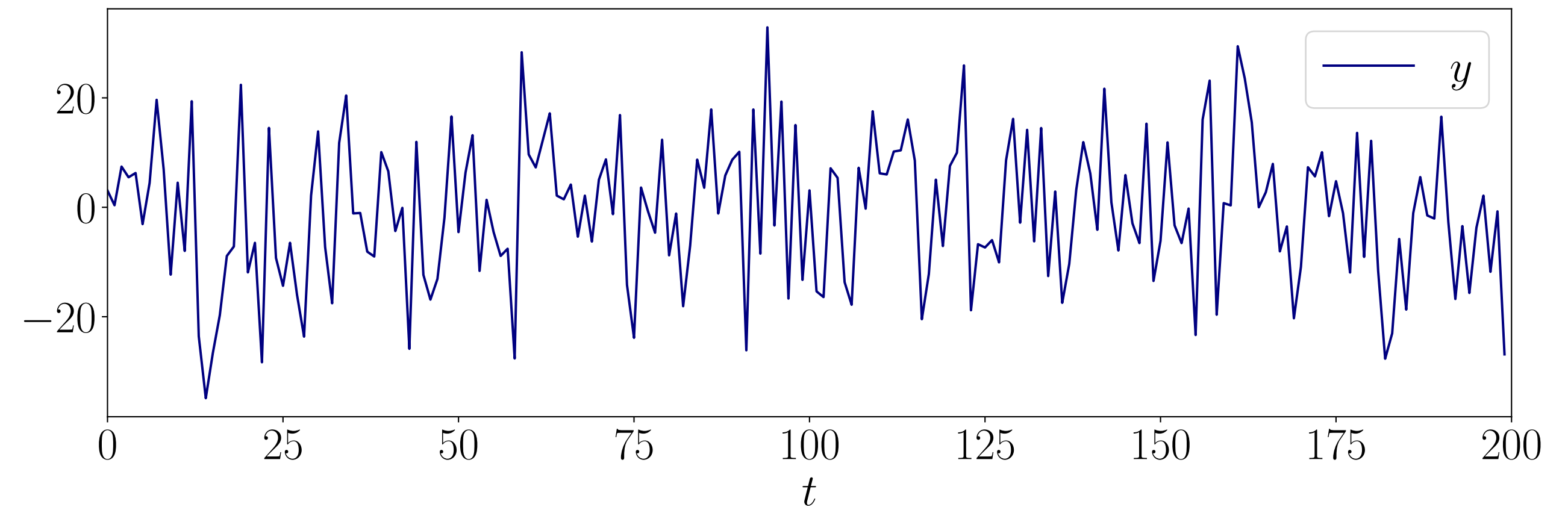

Exact message decoded!

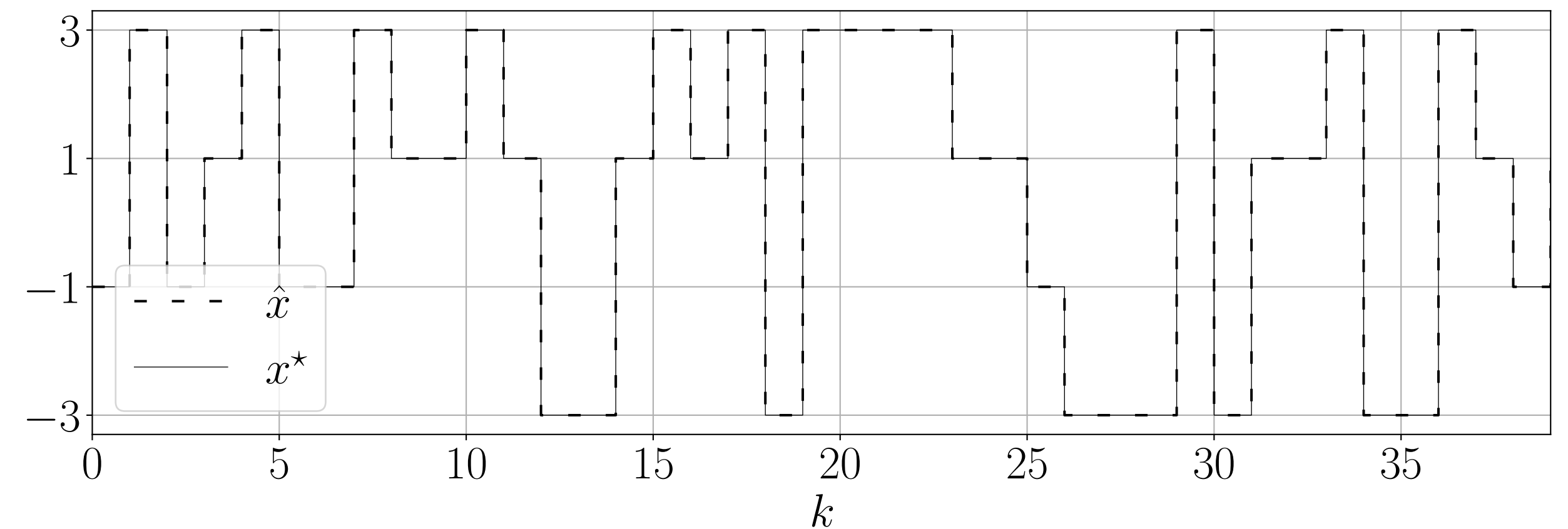

Relaxations

Relaxations

$$\begin{aligned} &\text{minimize} && c^T x \\ &\text{subject to} && Ax \leq b \\ &&& x_i \in \mathbf{Z}, \quad i \in \mathcal{I} \end{aligned}$$

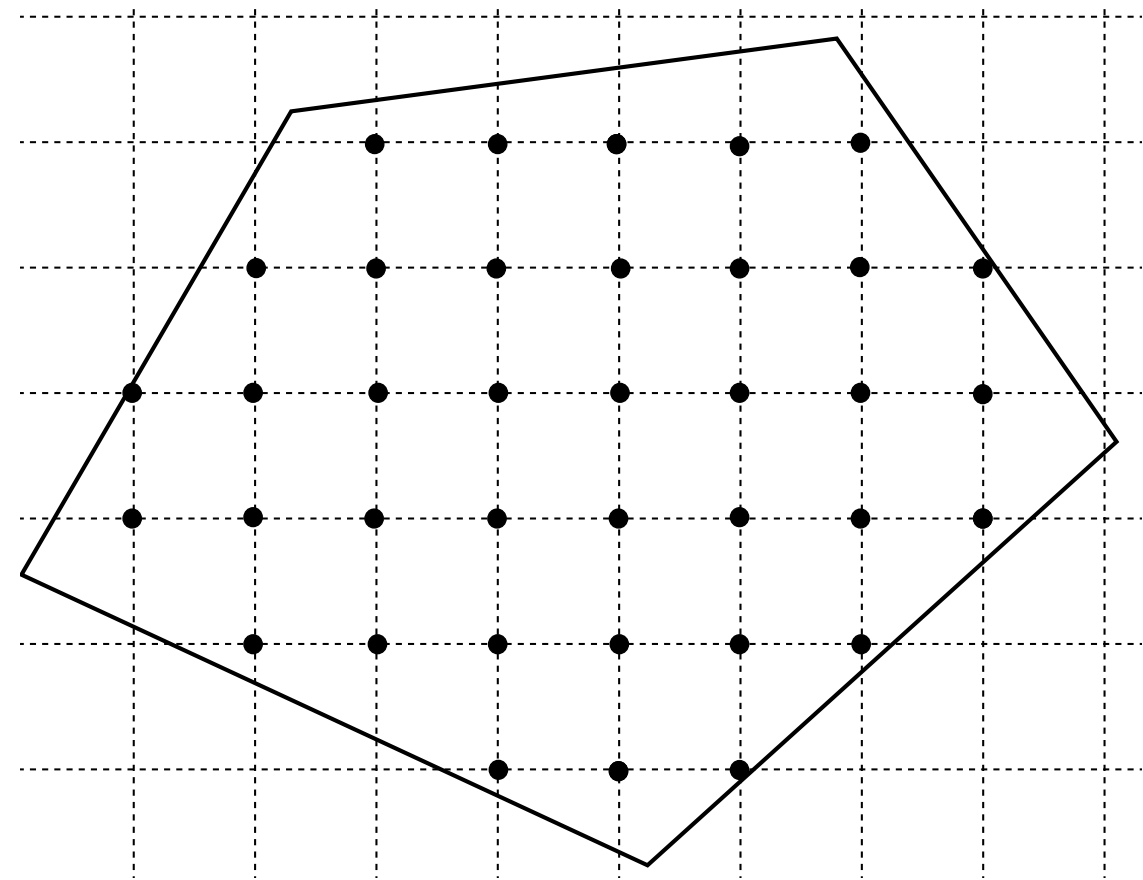

Relaxations

Remove integrality constraints

$$\begin{aligned} &\text{minimize} && c^T x \\ &\text{subject to} && Ax \leq b \\ &&& x_i \in \mathbf{Z}, \quad i \in \mathcal{I} \end{aligned}$$



$$\begin{aligned} &\text{minimize} && c^T x \\ &\text{subject to} && Ax \leq b \end{aligned}$$

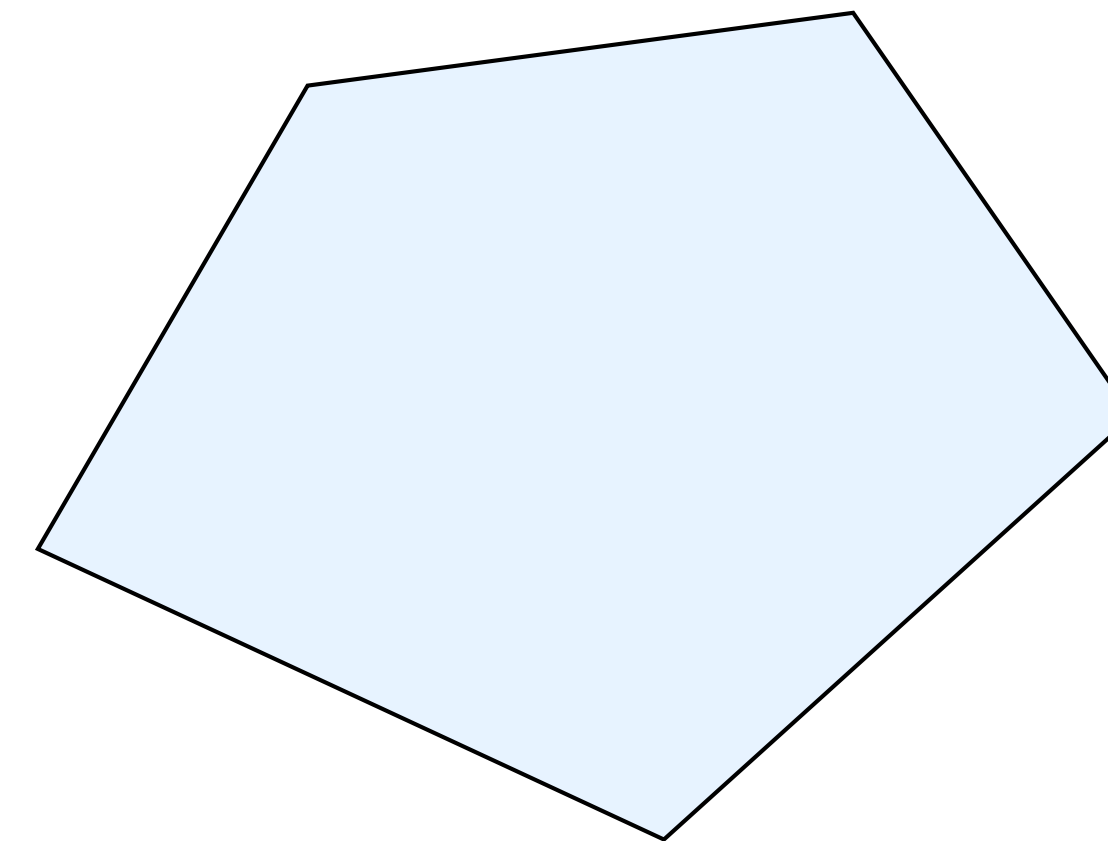
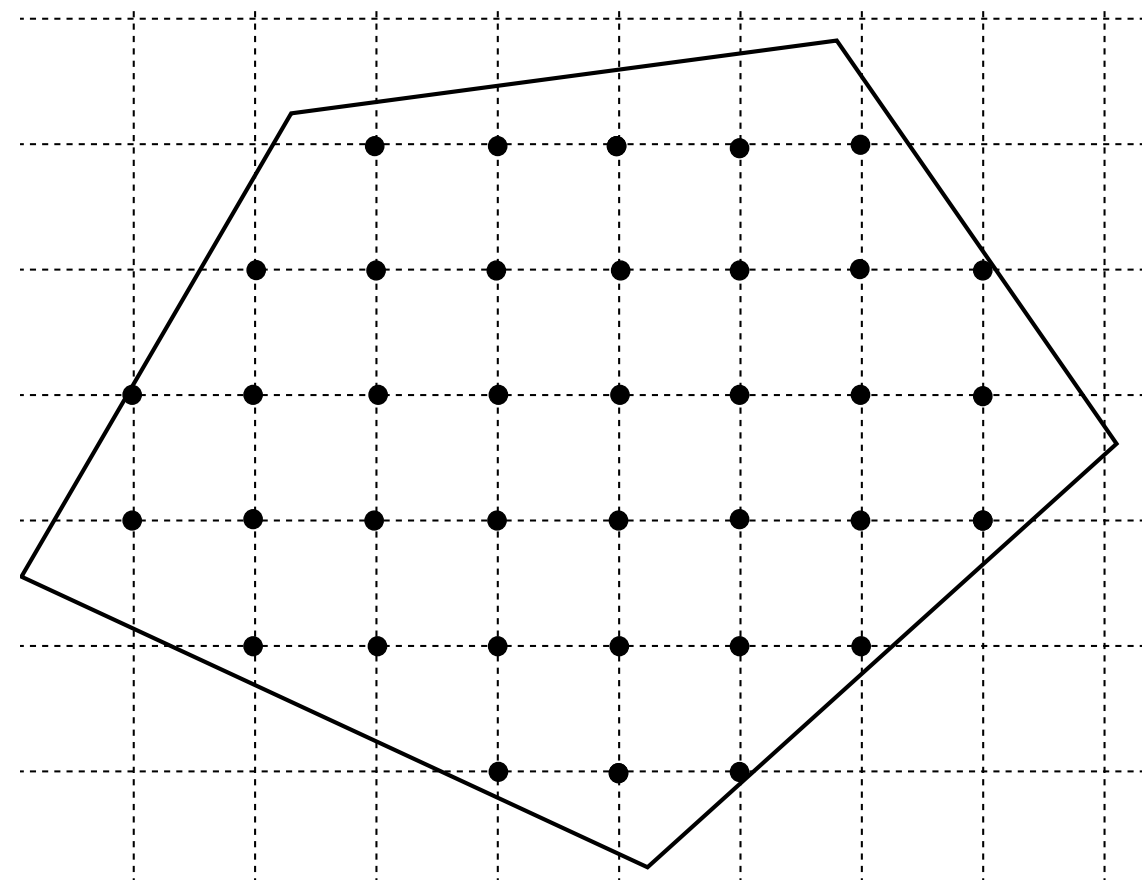

Relaxations

Remove integrality constraints

P_{ip} \longrightarrow minimize $c^T x$
subject to $Ax \leq b$
 $x_i \in \mathbf{Z}, \quad i \in \mathcal{I}$

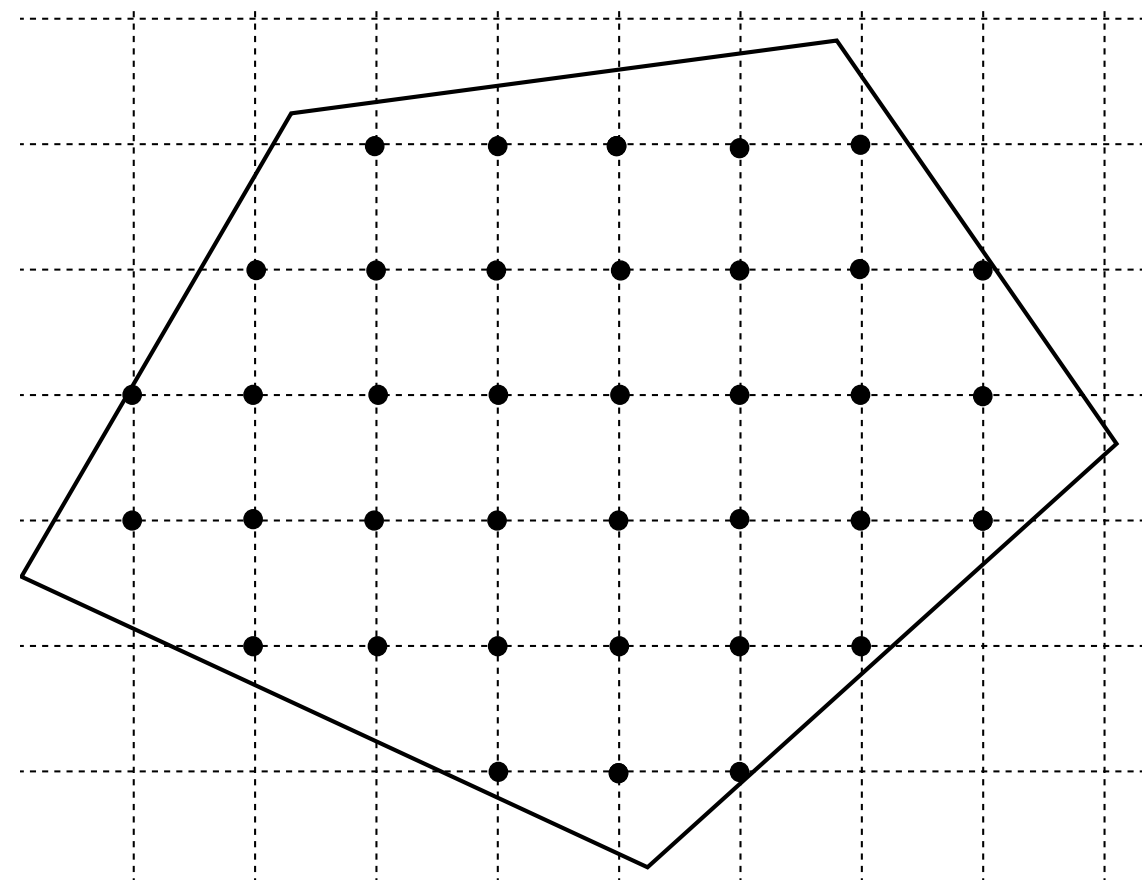

minimize $c^T x$
subject to $Ax \leq b$ $\longleftarrow P_{\text{rel}}$

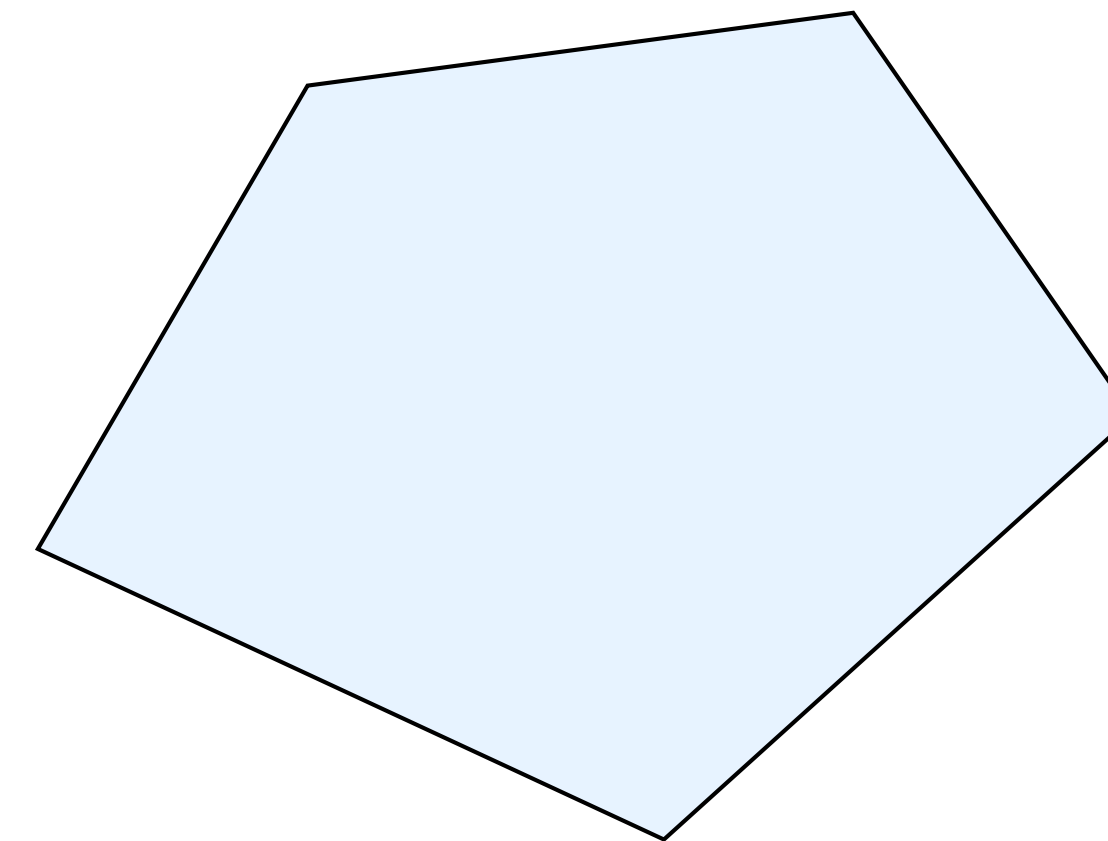

Relaxations

Remove integrality constraints

minimize $c^T x$
subject to $Ax \leq b$
 $x_i \in \mathbf{Z}, \quad i \in \mathcal{I}$

P_{ip} \longrightarrow

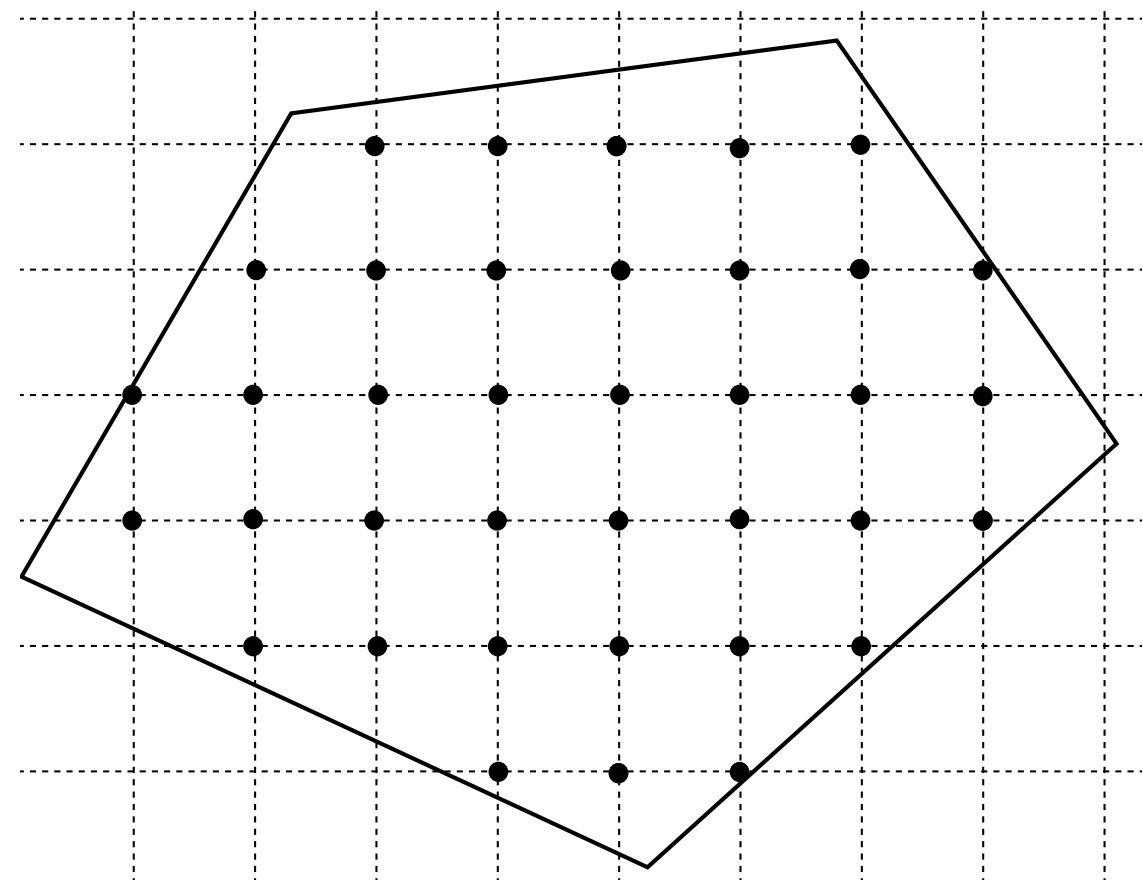

minimize $c^T x$
subject to $Ax \leq b$

P_{rel} \longleftarrow

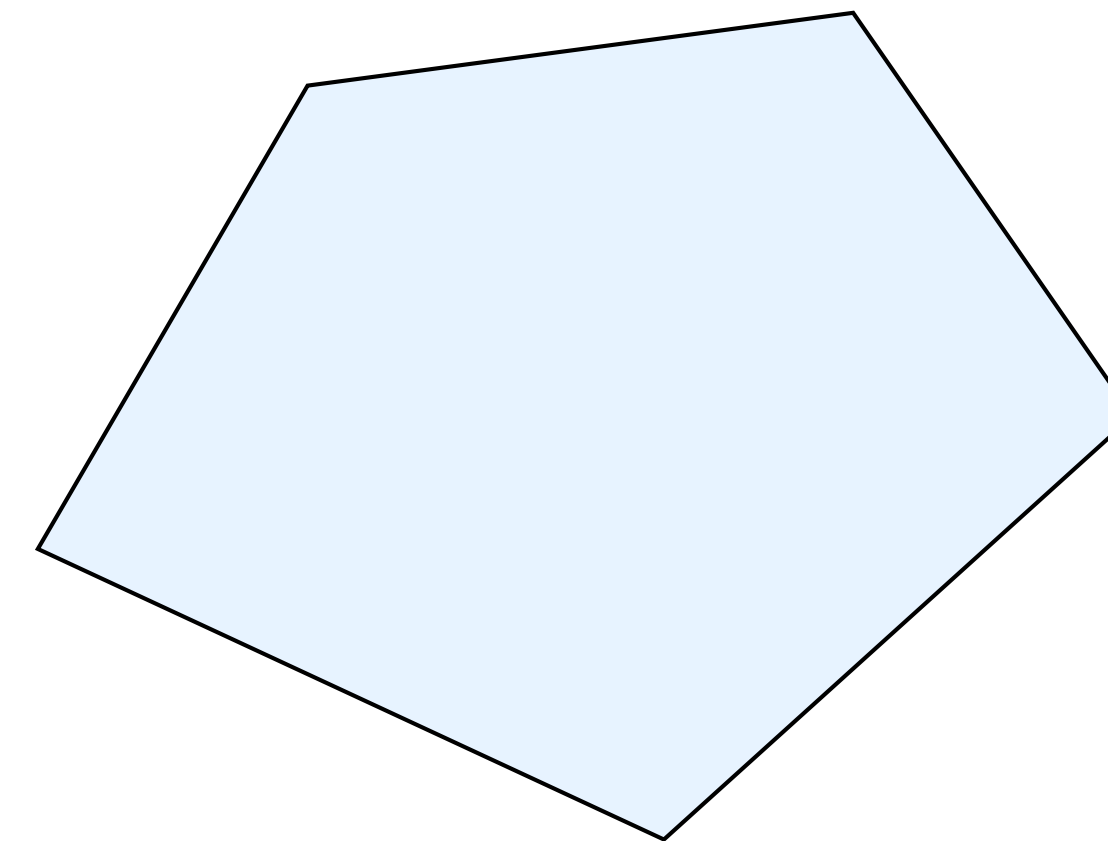

$P_{\text{ip}} \subset P_{\text{rel}}$



Relaxations provide
lower bounds to p_{ip}^*
 $p_{\text{rel}}^* \leq p_{\text{ip}}^*$

Multiple formulations exist

Equivalent formulations
(same feasible points)
with different relaxations

$$\begin{aligned} &\text{minimize} && c^T x \\ &\text{subject to} && Ax \leq b \\ &&& x_i \in \mathbf{Z}, \quad i \in \mathcal{I} \end{aligned}$$

Formulation 1

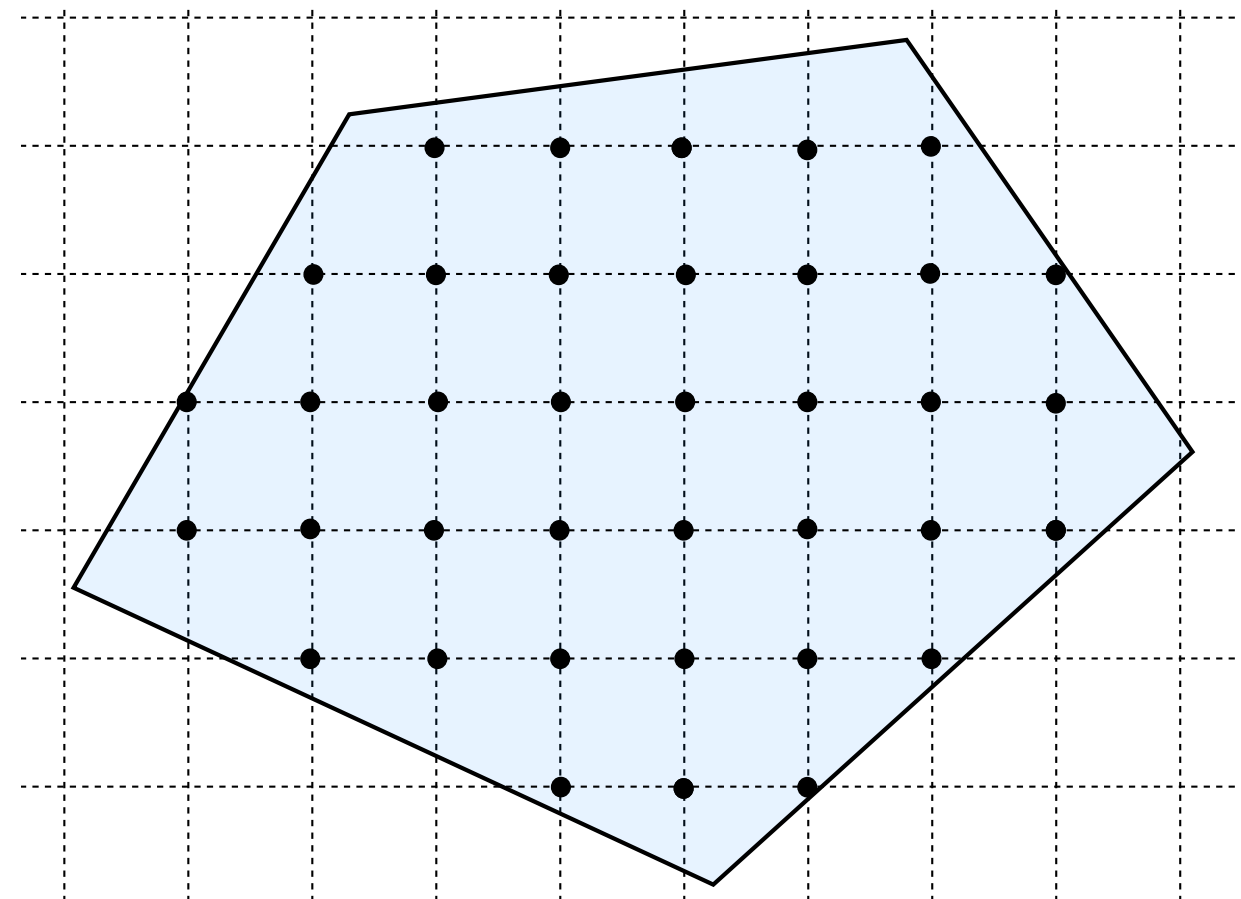

Formulation 2

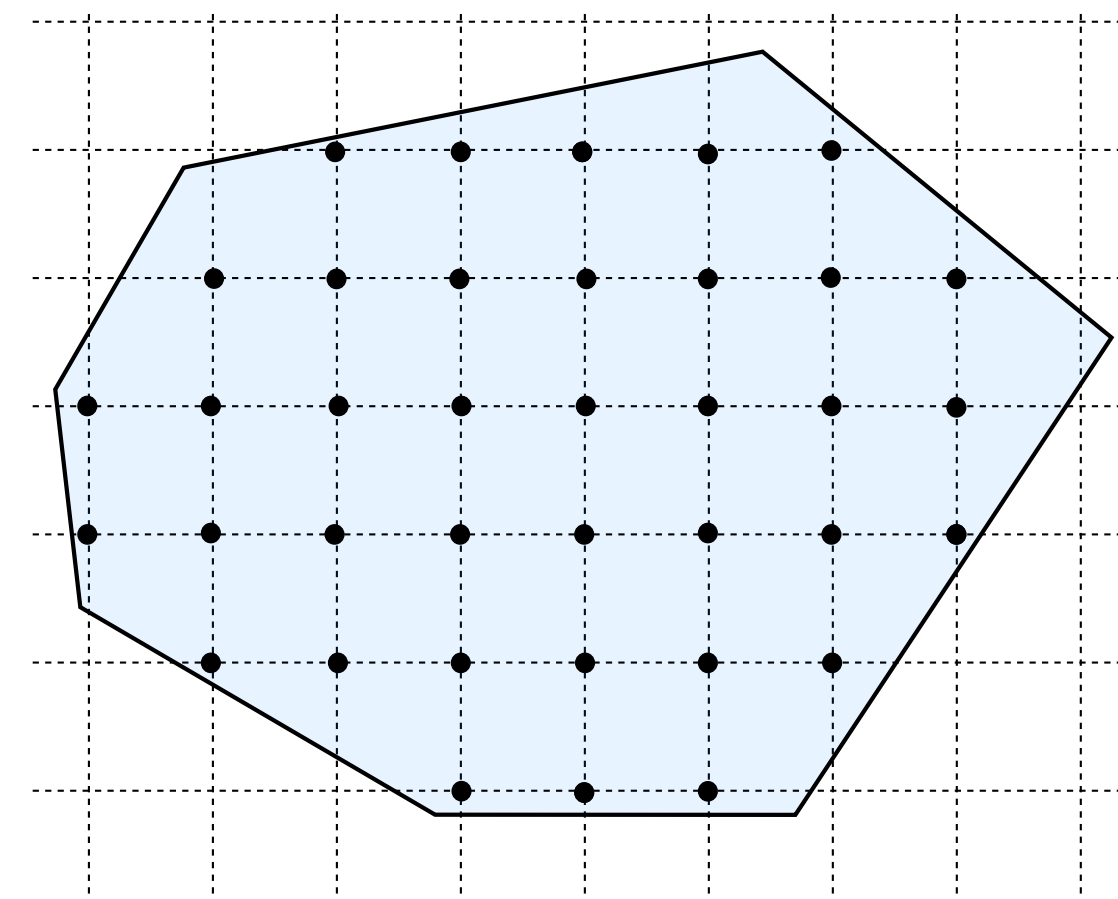

Multiple formulations exist

$$\begin{aligned} &\text{minimize} && c^T x \\ &\text{subject to} && Ax \leq b \\ &&& x_i \in \mathbf{Z}, \quad i \in \mathcal{I} \end{aligned}$$

Equivalent formulations
(same feasible points)
with different relaxations

Formulation 1

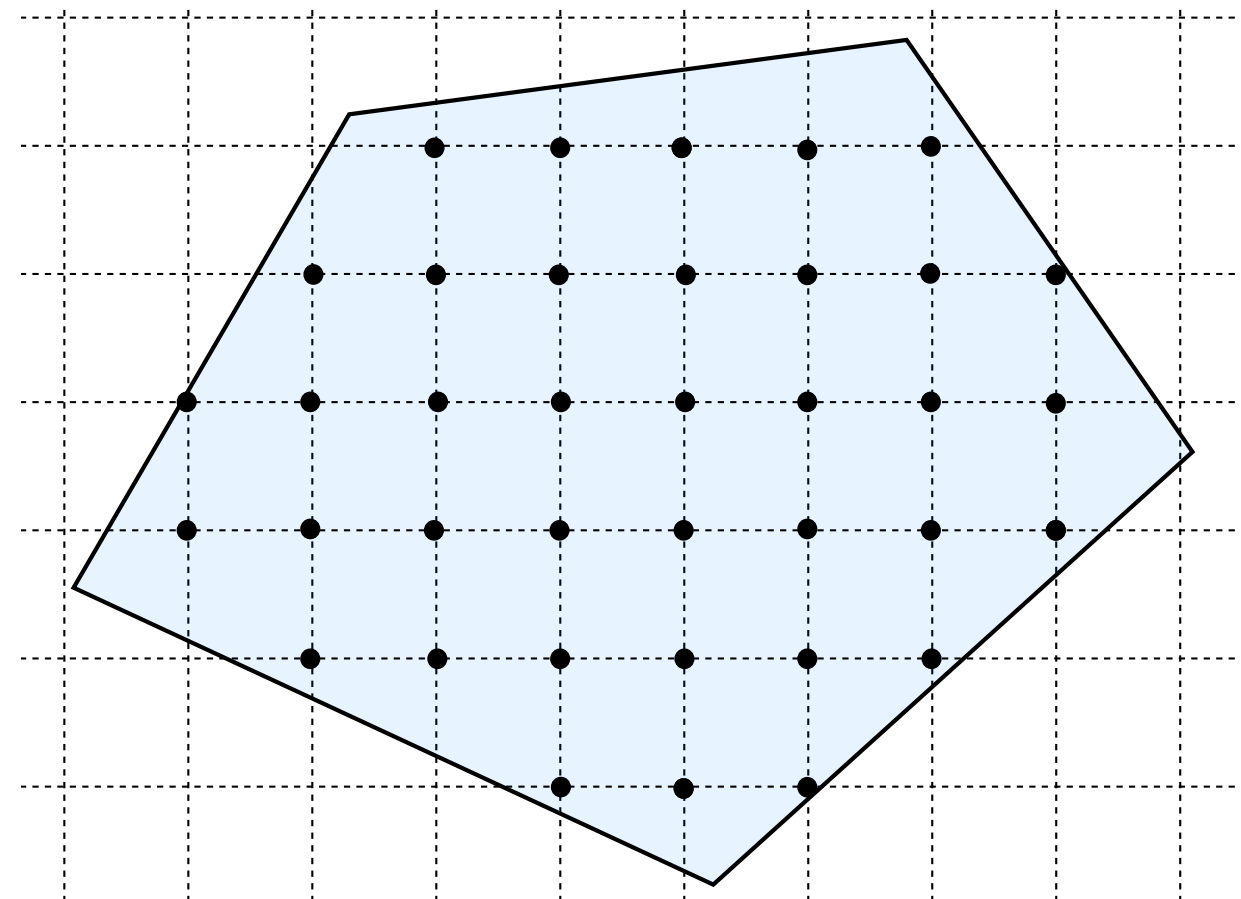

Formulation 2

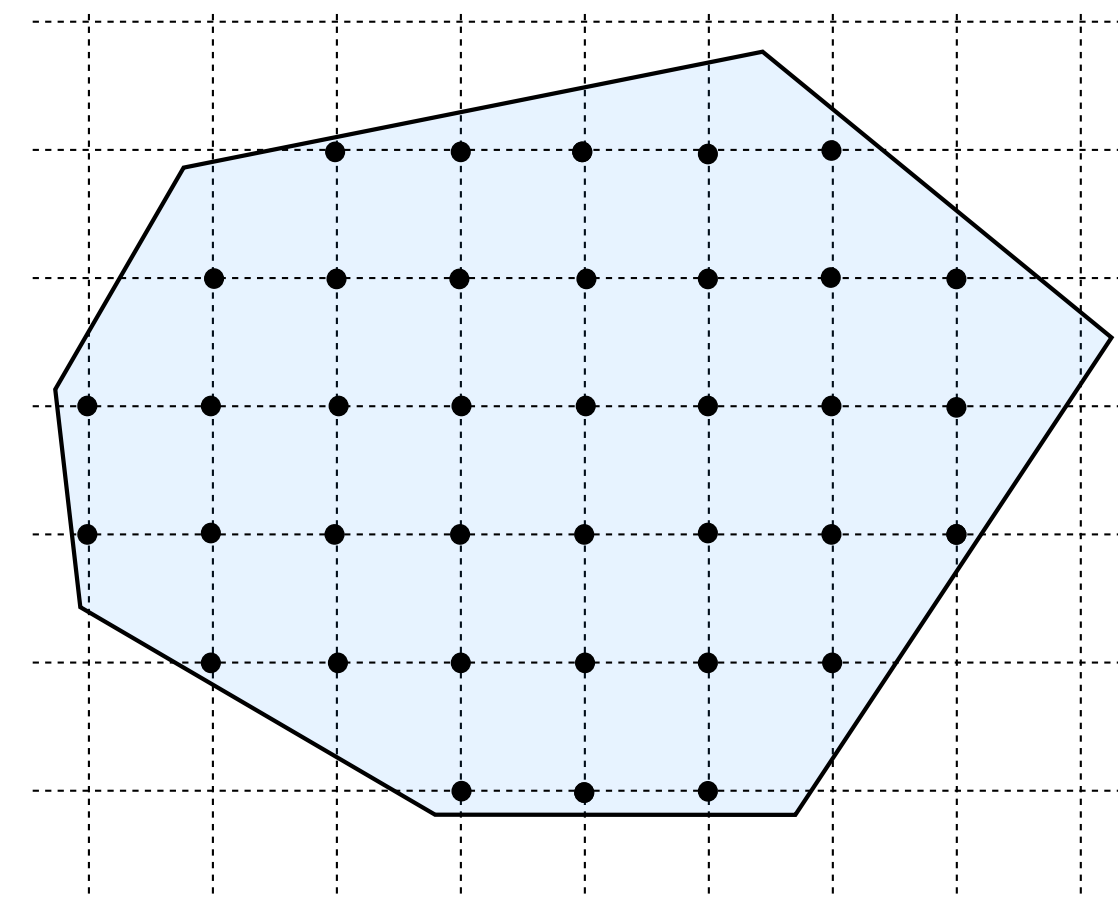

Which one is better?

$$p_{\text{rel1}}^* \begin{matrix} \leq \\ \geq \\ = \end{matrix} p_{\text{rel2}}^* ?$$

Facility location problem

Multiple formulations

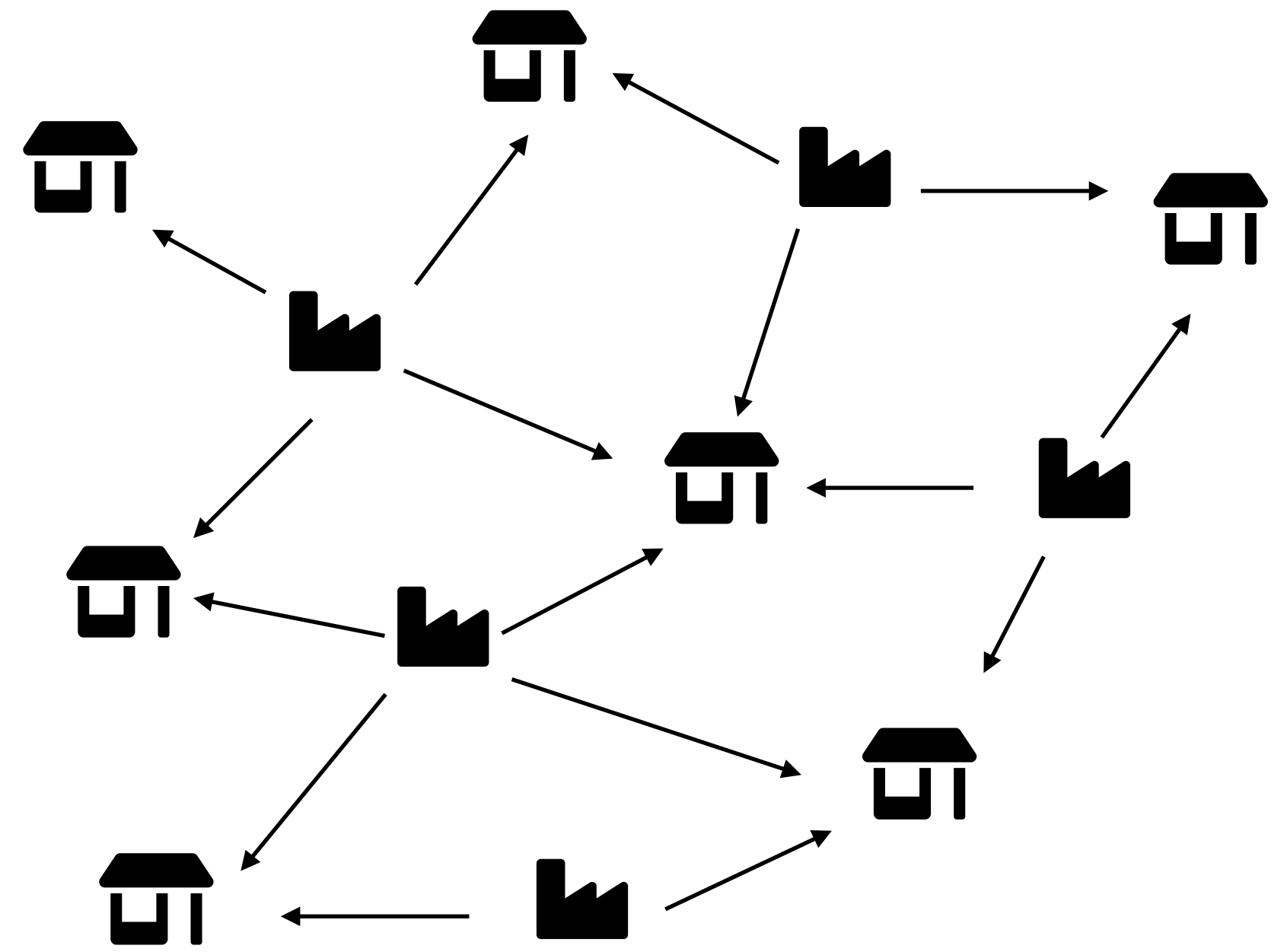

Facility location problem

Multiple formulations

Formulation 1

$$\begin{aligned} &\text{minimize} && \sum_{j=1}^n c_j y_j + \sum_{i=1}^m \sum_{j=1}^n d_{ij} x_{ij} \\ &\text{subject to} && \sum_{j=1}^n x_{ij} = 1, \quad i = 1, \dots, m \\ &&& x_{ij} \leq y_j, \quad i = 1, \dots, m, \quad j = 1, \dots, n \\ &&& x_{ij}, y_j \in \{0, 1\} \end{aligned}$$

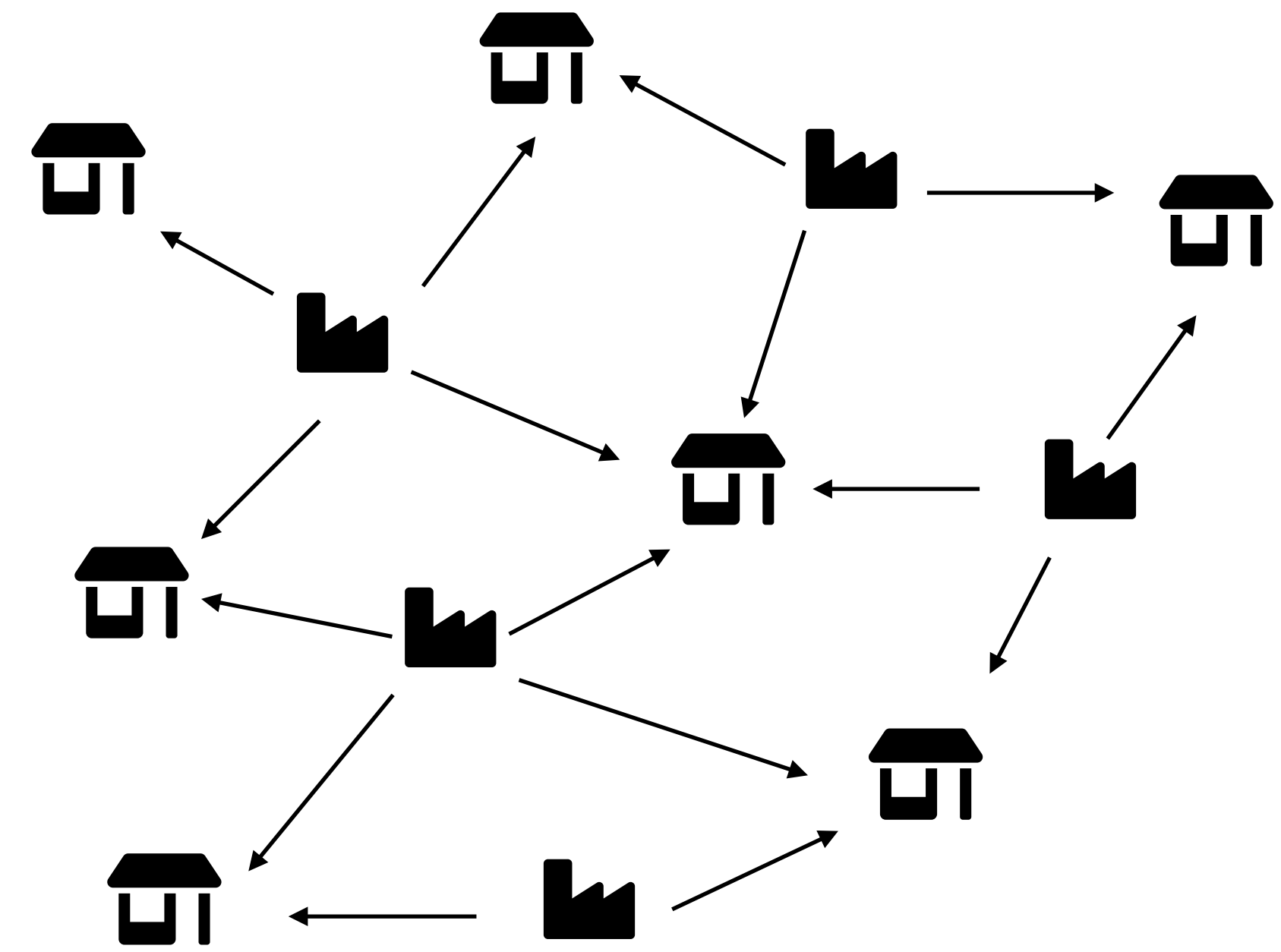

Facility location problem

Multiple formulations

Formulation 1

$$\begin{aligned} &\text{minimize} && \sum_{j=1}^n c_j y_j + \sum_{i=1}^m \sum_{j=1}^n d_{ij} x_{ij} \\ &\text{subject to} && \sum_{j=1}^n x_{ij} = 1, \quad i = 1, \dots, m \\ &&& x_{ij} \leq y_j, \quad i = 1, \dots, m, \quad j = 1, \dots, n \\ &&& x_{ij}, y_j \in \{0, 1\} \end{aligned}$$

Formulation 2 (fewer constraints)

$$\begin{aligned} &\text{minimize} && \sum_{j=1}^n c_j y_j + \sum_{i=1}^m \sum_{j=1}^n d_{ij} x_{ij} \\ &\text{subject to} && \sum_{j=1}^n x_{ij} = 1, \quad i = 1, \dots, m \\ &&& \sum_{i=1}^m x_{ij} \leq m y_j, \quad j = 1, \dots, n \\ &&& x_{ij}, y_j \in \{0, 1\} \end{aligned}$$

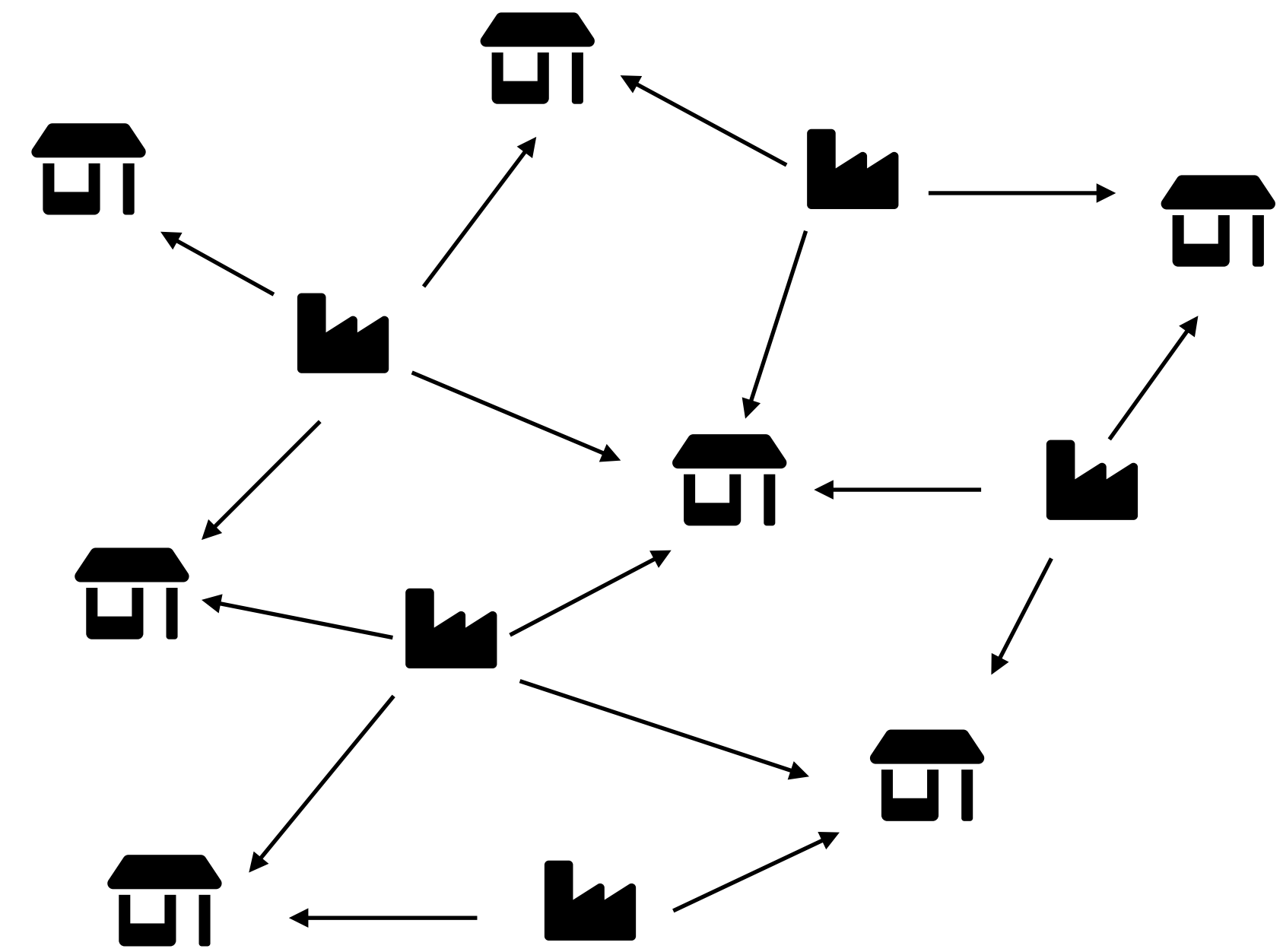

Facility location problem

Multiple formulations

Formulation 1

$$\text{minimize } \sum_{j=1}^n c_j y_j + \sum_{i=1}^m \sum_{j=1}^n d_{ij} x_{ij}$$

$$\text{subject to } \sum_{j=1}^n x_{ij} = 1, \quad i = 1, \dots, m$$

$$x_{ij} \leq y_j, \quad i = 1, \dots, m, \quad j = 1, \dots, n$$

$$x_{ij}, y_j \in \{0, 1\}$$

Formulation 2 (fewer constraints)

$$\text{minimize } \sum_{j=1}^n c_j y_j + \sum_{i=1}^m \sum_{j=1}^n d_{ij} x_{ij}$$

$$\text{subject to } \sum_{j=1}^n x_{ij} = 1, \quad i = 1, \dots, m$$

$$\sum_{i=1}^m x_{ij} \leq m y_j, \quad j = 1, \dots, n$$

$$x_{ij}, y_j \in \{0, 1\}$$

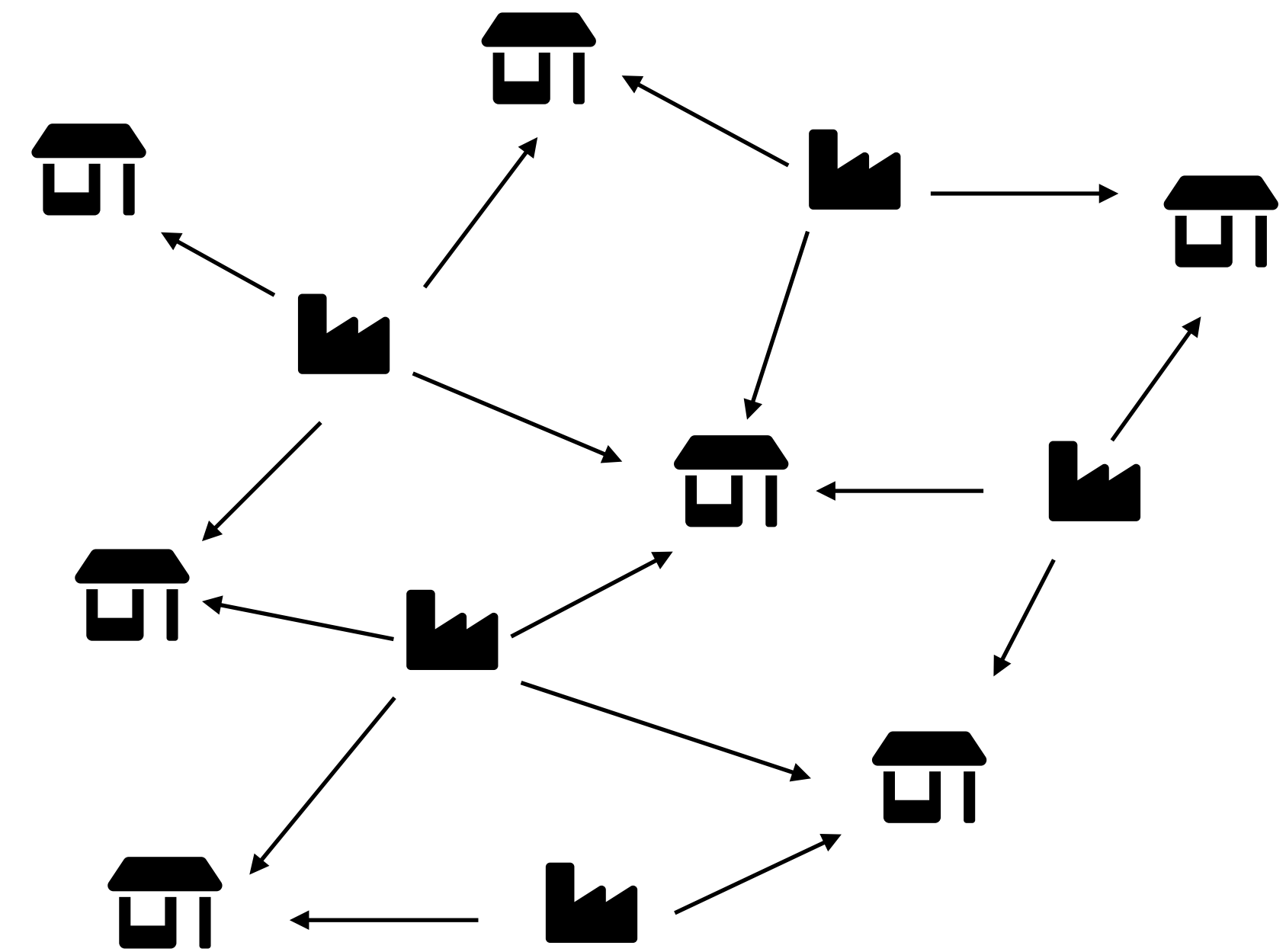

Are they both valid?

Facility location problem

Multiple formulations

Formulation 1

$$\text{minimize } \sum_{j=1}^n c_j y_j + \sum_{i=1}^m \sum_{j=1}^n d_{ij} x_{ij}$$

$$\text{subject to } \sum_{j=1}^n x_{ij} = 1, \quad i = 1, \dots, m$$

$$x_{ij} \leq y_j, \quad i = 1, \dots, m, \quad j = 1, \dots, n$$

$$x_{ij}, y_j \in \{0, 1\}$$

Formulation 2 (fewer constraints)

$$\text{minimize } \sum_{j=1}^n c_j y_j + \sum_{i=1}^m \sum_{j=1}^n d_{ij} x_{ij}$$

$$\text{subject to } \sum_{j=1}^n x_{ij} = 1, \quad i = 1, \dots, m$$

$$\sum_{i=1}^m x_{ij} \leq m y_j, \quad j = 1, \dots, n$$

$$x_{ij}, y_j \in \{0, 1\}$$

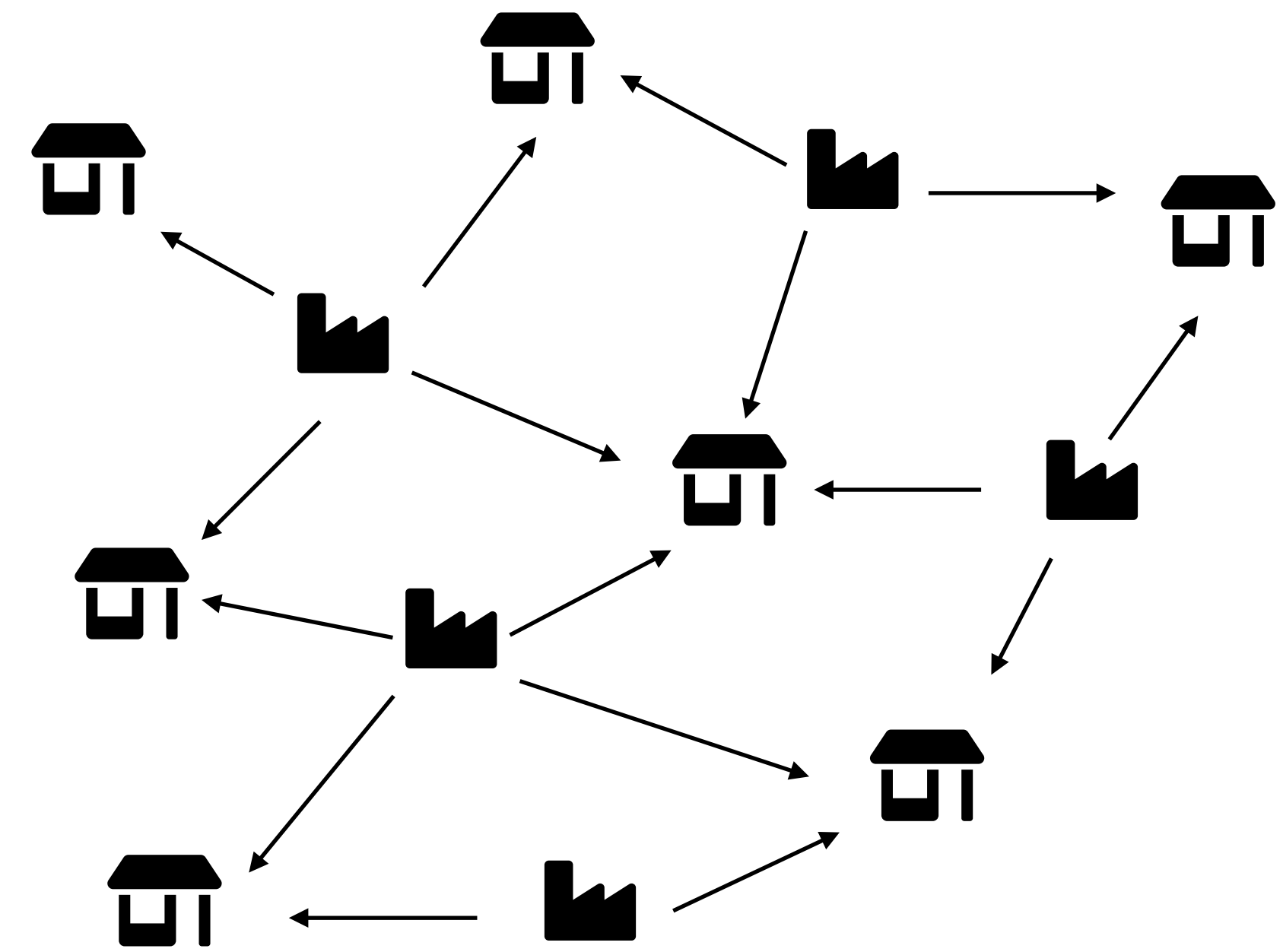

Are they both valid?

Which one is better?

Facility location problem

Multiple formulations

Formulation 1

$$P_{\text{rel1}} = \left\{ \sum_{j=1}^n x_{ij} = 1, \quad x_{ij} \leq y_j, \quad x_{ij}, y_j \in [0, 1] \right\}$$

Formulation 2

$$P_{\text{rel2}} = \left\{ \sum_{j=1}^n x_{ij} = 1, \quad \sum_{i=1}^m x_{ij} \leq m y_j, \quad x_{ij}, y_j \in [0, 1] \right\}$$

Facility location problem

Multiple formulations

Formulation 1

$$P_{\text{rel1}} = \left\{ \sum_{j=1}^n x_{ij} = 1, \quad x_{ij} \leq y_j, \quad x_{ij}, y_j \in [0, 1] \right\}$$

Formulation 2

$$P_{\text{rel2}} = \left\{ \sum_{j=1}^n x_{ij} = 1, \quad \sum_{i=1}^m x_{ij} \leq m y_j, \quad x_{ij}, y_j \in [0, 1] \right\}$$

Relationship

$$P_{\text{rel1}} \subset P_{\text{rel2}} \implies p_{\text{rel2}}^* \leq p_{\text{rel1}}^* \leq p^* = p_1^* = p_2^*$$

**Formulation 1
is better**

Facility location problem

Multiple formulations proof $P_{\text{rel1}} \subset P_{\text{rel2}}$

Formulation 1: P_{rel1}

$$x_{ij} \leq y_j, \forall i, j \iff \max_i x_{ij} \leq y_j$$

Formulation 2: P_{rel2}

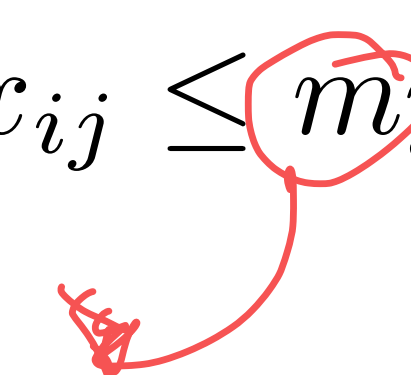
$$\sum_{i=1}^m x_{ij} \leq m y_j, \forall j \iff \text{avg}_i x_{ij} \leq y_j$$

Facility location problem

Multiple formulations proof $P_{\text{rel1}} \subset P_{\text{rel2}}$

Formulation 1: P_{rel1}

$$x_{ij} \leq y_j, \forall i, j \iff \max_i x_{ij} \leq y_j$$

Maximum less than y_j
implies average less than y_j

Formulation 2: P_{rel2}

$$\sum_{i=1}^m x_{ij} \leq my_j, \forall j \iff \mathbf{avg}_i x_{ij} \leq y_j$$



$$P_{\text{rel1}} \subseteq P_{\text{rel2}}$$

Facility location problem

Multiple formulations proof $P_{\text{rel1}} \subset P_{\text{rel2}}$

Formulation 1: P_{rel1}

$$x_{ij} \leq y_j, \forall i, j \iff \max_i x_{ij} \leq y_j$$

Maximum less than y_j
implies average less than y_j

Average less than y_j
doesn't imply maximum less than y_j

- $(x_{1j}, x_{2j}, x_{3j}) = (0.3, 0.4, 0.5)$
- $y_j = 0.45$

Formulation 2: P_{rel2}

$$\sum_{i=1}^m x_{ij} \leq my_j, \forall j \iff \text{avg}_i x_{ij} \leq y_j$$



$$P_{\text{rel1}} \subseteq P_{\text{rel2}}$$



$$P_{\text{rel1}} \neq P_{\text{rel2}}$$

$$P_{\text{rel1}} \subset P_{\text{rel2}}$$



Ideal formulations

What's the best possible formulation?

Problem

$$\begin{aligned} &\text{minimize} && c^T x \\ &\text{subject to} && Ax \leq b \\ &&& x_i \in \mathbf{Z}, \quad i \in \mathcal{I} \end{aligned}$$

Relaxation

$$\begin{aligned} &\text{minimize} && c^T x \\ &\text{subject to} && Ax \leq b \end{aligned}$$

What's the best possible formulation?

Problem

$$\begin{aligned} &\text{minimize} && c^T x \\ &\text{subject to} && Ax \leq b \\ &&& x_i \in \mathbf{Z}, \quad i \in \mathcal{I} \end{aligned}$$

Relaxation

$$\begin{aligned} &\text{minimize} && c^T x \\ &\text{subject to} && Ax \leq b \end{aligned}$$

What happens if the relaxation solution is integer feasible point?

What's the best possible formulation?

Problem

$$\begin{aligned} &\text{minimize} && c^T x \\ &\text{subject to} && Ax \leq b \\ &&& x_i \in \mathbf{Z}, \quad i \in \mathcal{I} \end{aligned}$$

Relaxation

$$\begin{aligned} &\text{minimize} && c^T x \\ &\text{subject to} && Ax \leq b \end{aligned}$$

What happens if the relaxation solution is integer feasible point?

We found an optimal solution!

What's the best possible formulation?

Problem

$$\begin{aligned} &\text{minimize} && c^T x \\ &\text{subject to} && Ax \leq b \\ &&& x_i \in \mathbf{Z}, \quad i \in \mathcal{I} \end{aligned}$$

Relaxation

$$\begin{aligned} &\text{minimize} && c^T x \\ &\text{subject to} && Ax \leq b \end{aligned}$$

What happens if the relaxation solution is integer feasible point?

We found an optimal solution!

Does this formulation always exist?

Convex hull

Recap

The **convex hull** is the set of all possible convex combinations of the points.

$$\text{conv } C = \left\{ \sum_{i=1}^n \alpha_i x_i \mid \alpha \geq 0, \quad \mathbf{1}^T \alpha = 1 \right\}$$

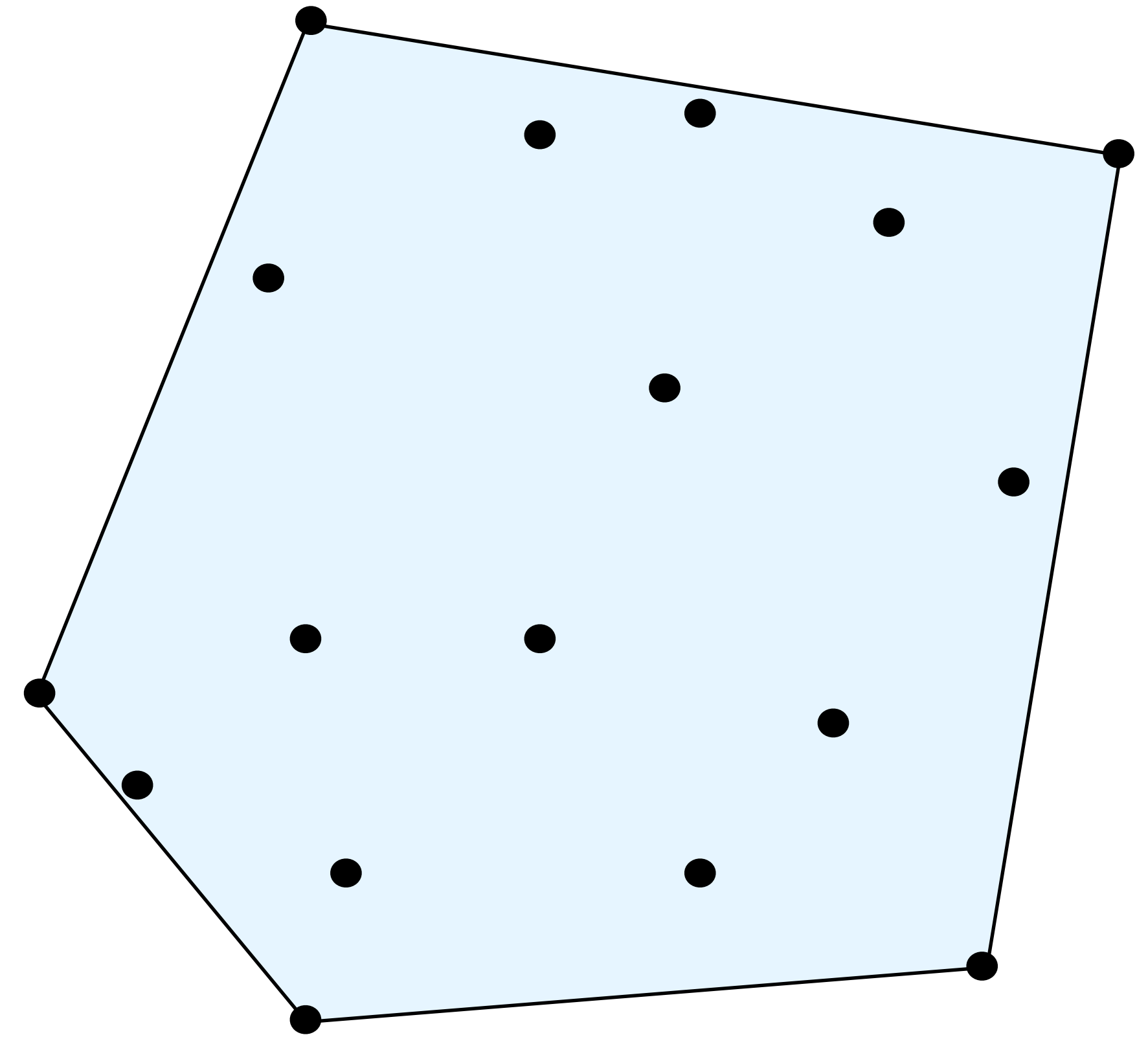

Convex hull

Recap

The **convex hull** is the set of all possible convex combinations of the points.

$$\text{conv } C = \left\{ \sum_{i=1}^n \alpha_i x_i \mid \alpha \geq 0, \quad \mathbf{1}^T \alpha = 1 \right\}$$

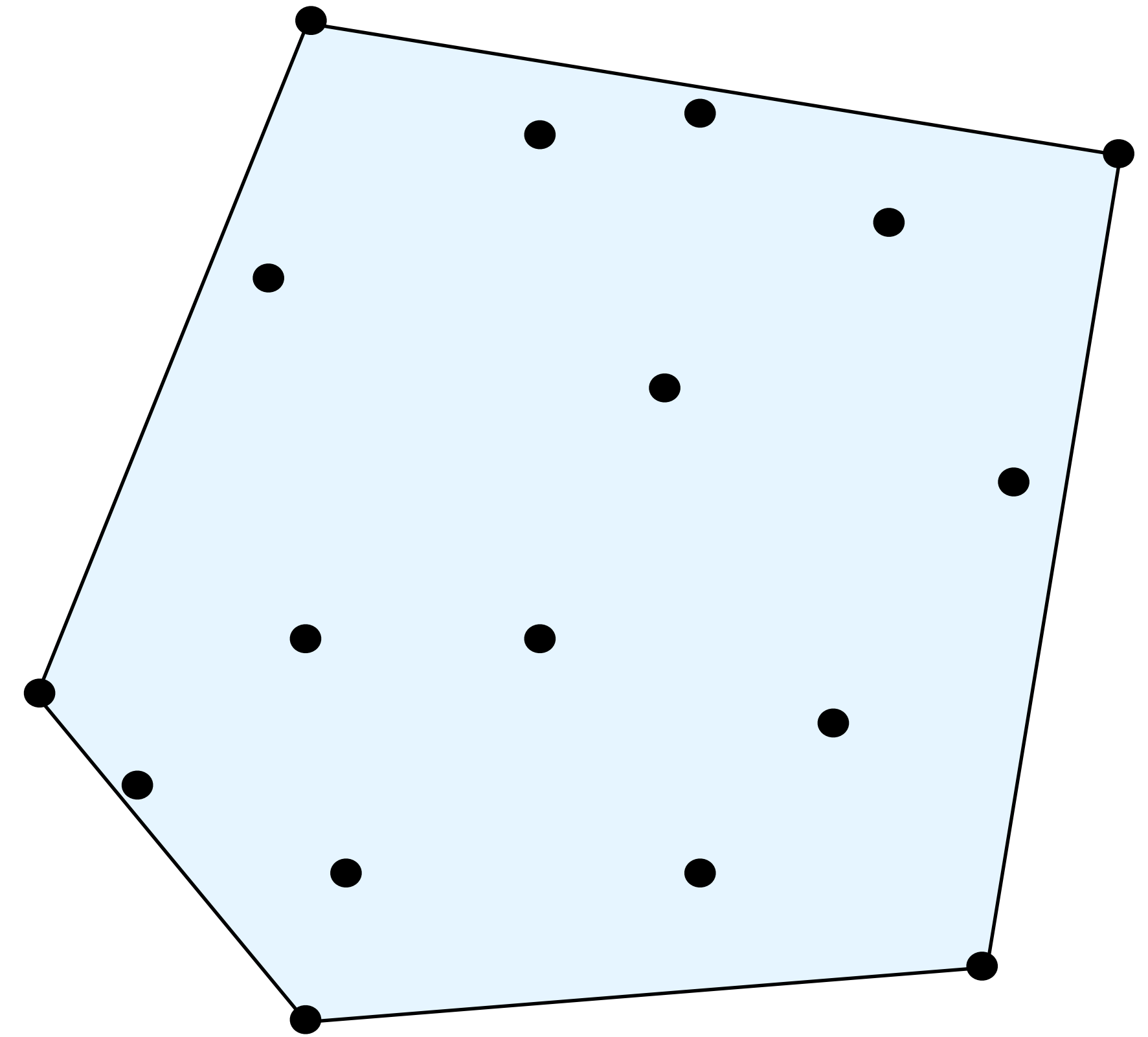

What is the convex hull of an integer optimization problem?

Convex hull of integer optimization

$$\begin{array}{ll} \text{minimize} & c^T x \\ \text{subject to} & Ax \leq b \\ & x_i \in \mathbf{Z}, \quad i \in \mathcal{I} \end{array}$$

**The convex hull has
integer feasible extreme points**

$$\text{conv } P = \text{conv}\{x \mid Ax \leq b, \quad x_i \in \mathbf{Z}, \quad i \in \mathcal{I}\}$$

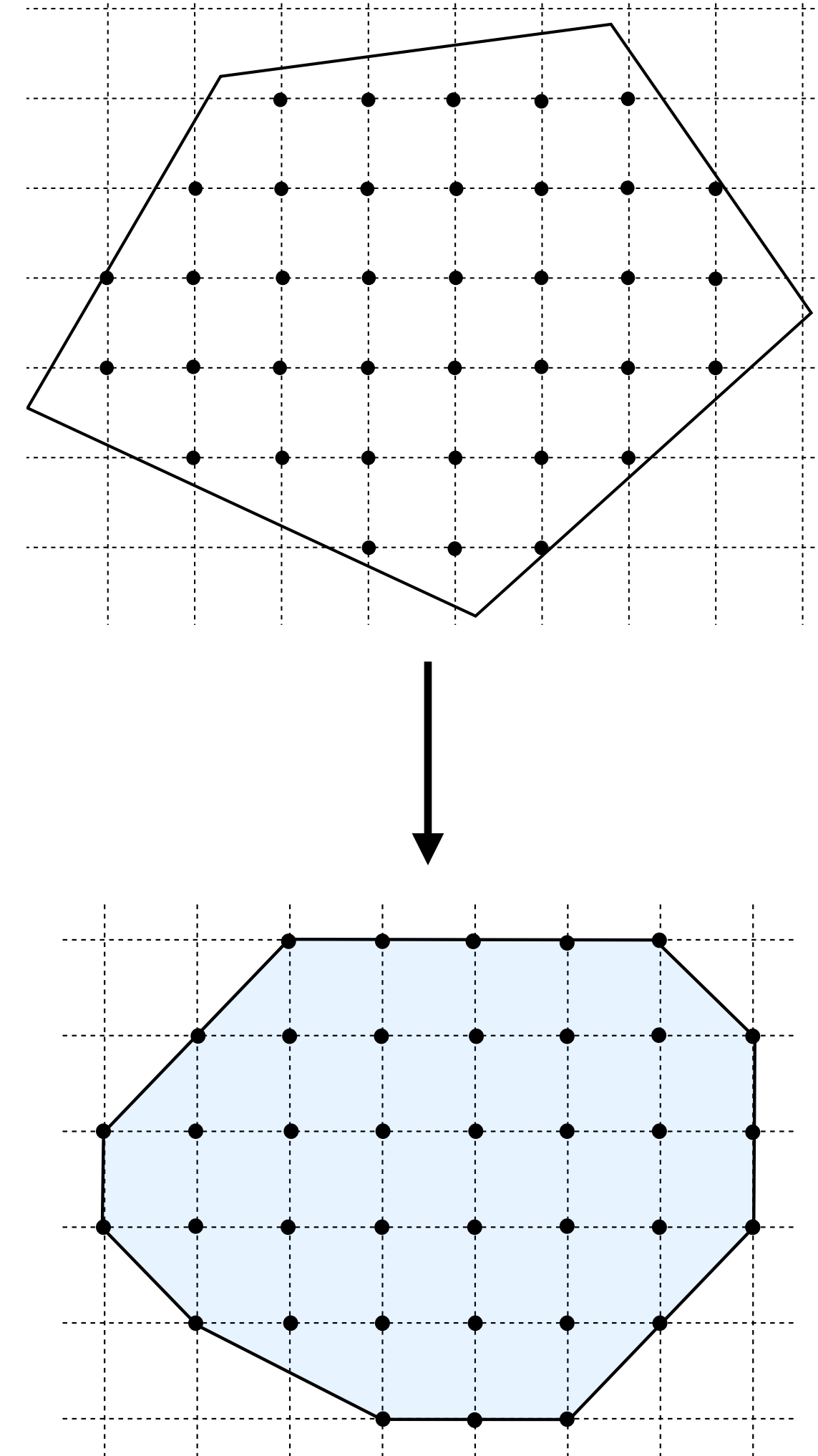

Ideal formulations

A formulation is ideal if solving its relaxation gives an integer feasible point

$$\begin{array}{ll} \text{minimize} & c^T x \\ \text{subject to} & Ax \leq b \\ & x_i \in \mathbf{Z}, \quad i \in \mathcal{I} \end{array}$$

Ideal formulations

A formulation is ideal if solving its relaxation gives an integer feasible point

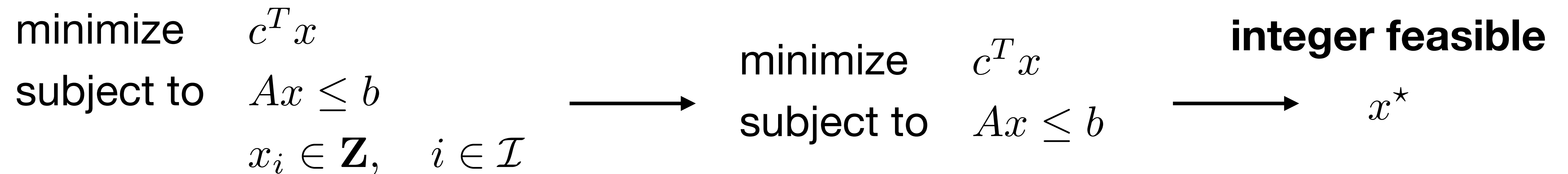

Ideal formulations

A formulation is ideal if solving its relaxation gives an integer feasible point

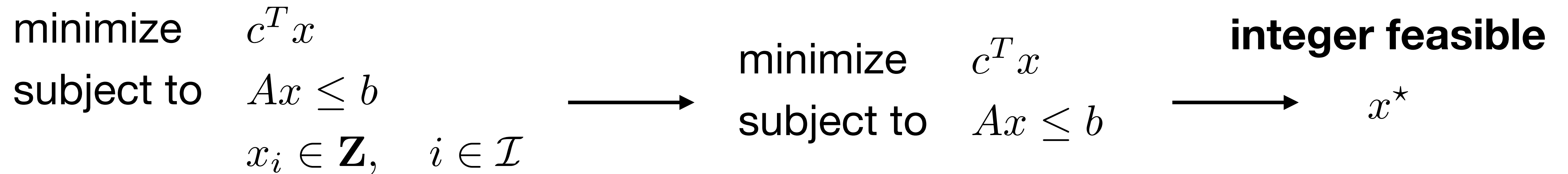

This happens if
 $\text{conv } P = \{Ax \leq b\}$

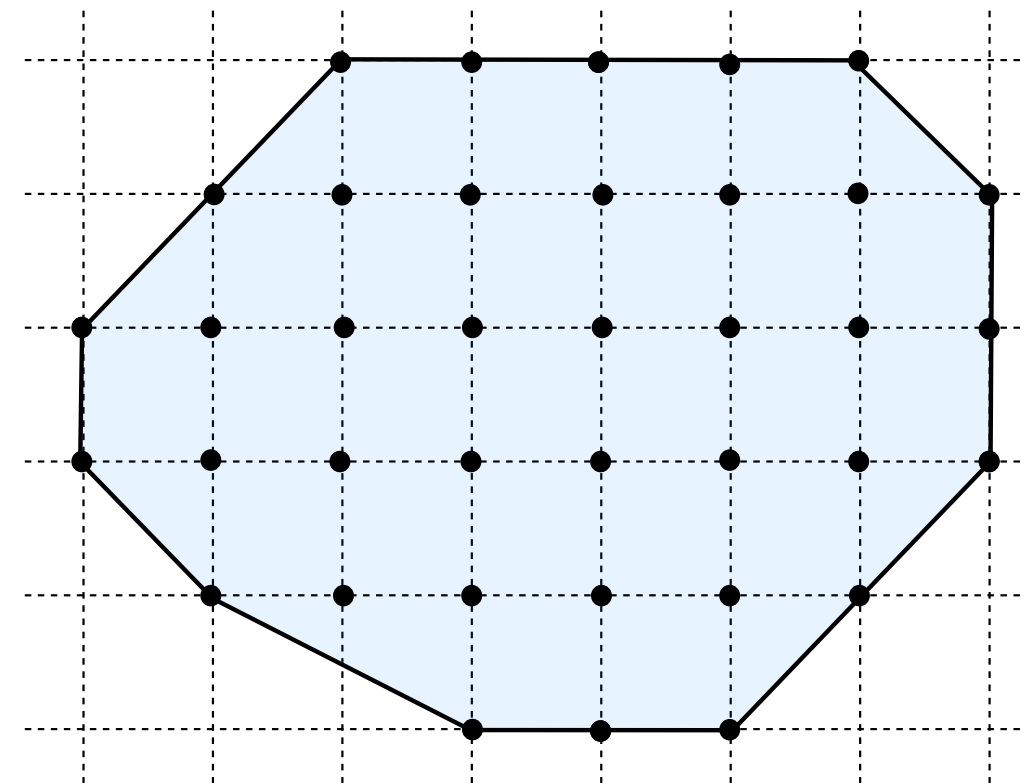

Ideal formulations

A formulation is ideal if solving its relaxation gives an integer feasible point

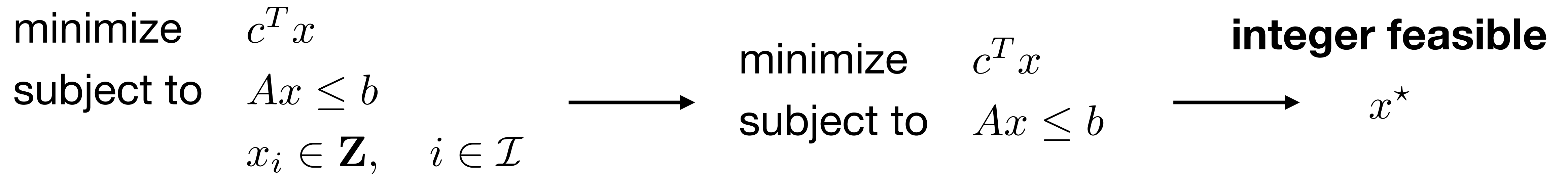

This happens if
 $\text{conv } P = \{Ax \leq b\}$

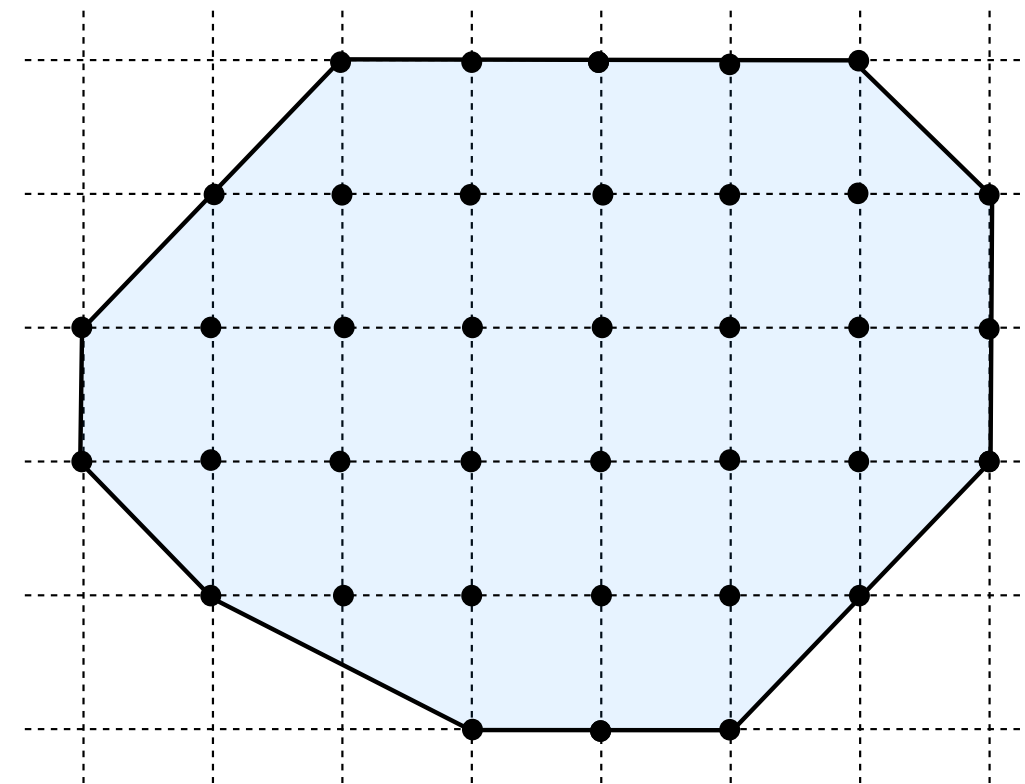

It is very hard to construct ideal formulations!

Facility location problem

Formulation 1

$$\begin{aligned} &\text{minimize} && \sum_{j=1}^n c_j y_j + \sum_{i=1}^m \sum_{j=1}^n d_{ij} x_{ij} \\ &\text{subject to} && \sum_{j=1}^n x_{ij} = 1, \quad i = 1, \dots, m \\ &&& x_{ij} \leq y_j, \quad i = 1, \dots, m, \quad j = 1, \dots, n \\ &&& x_{ij}, y_j \in \{0, 1\} \end{aligned}$$

Formulation 2 (fewer constraints)

$$\begin{aligned} &\text{minimize} && \sum_{j=1}^n c_j y_j + \sum_{i=1}^m \sum_{j=1}^n d_{ij} x_{ij} \\ &\text{subject to} && \sum_{j=1}^n x_{ij} = 1, \quad i = 1, \dots, m \\ &&& \sum_{i=1}^m x_{ij} \leq m y_j, \quad j = 1, \dots, n \\ &&& x_{ij}, y_j \in \{0, 1\} \end{aligned}$$

Ranking relaxations

$$\text{conv } P \subseteq P_{\text{rel1}} \subseteq P_{\text{rel2}}$$

$$p^* \geq p_{\text{rel1}}^* \geq p_{\text{rel2}}^*$$

Judging formulations

Size of feasible region

Goal: $\text{conv } P \approx \{Ax \leq b\}$

Objective function value

Goal: $p_{\text{rel}}^* \approx p_{\text{ip}}^*$

Problem size

Goal: keep moderate LP relaxation size
(unfortunately, better formulations
tend to have more
variables/constraints)

Problem formulation

minimize $c^T x$
subject to $Ax \leq b$
 $x_i \in \mathbf{Z}, \quad i \in \mathcal{I}$

Minimum cost network flow

$$\begin{array}{ll} \text{minimize} & c^T x \\ \text{subject to} & Ax = b \\ & 0 \leq x \leq u \end{array}$$



Integrality theorem
If A totally unimodular
(e.g., graph arc-node incidence)
 b and u are integral
solutions x^* are integral

Minimum cost network flow

$$\begin{array}{ll} \text{minimize} & c^T x \\ \text{subject to} & Ax = b \\ & 0 \leq x \leq u \end{array}$$



Integrality theorem
If A totally unimodular
(e.g., graph arc-node incidence)
 b and u are integral
solutions x^* are integral

Formulation is ideal

$$\begin{array}{ll} \text{minimize} & c^T x \\ \text{subject to} & Ax = b \\ & 0 \leq x \leq u \\ & x \in \mathbf{Z}^n \end{array}$$

**Very easy
special case!**

How do we solve integer optimization problems?

$$\begin{aligned} &\text{minimize} && c^T x \\ &\text{subject to} && Ax \leq b \\ &&& x_i \in \mathbf{Z}, \quad i \in \mathcal{I} \end{aligned}$$

Idea: Refine the feasible set until the relaxation gives integer feasible solutions!

Mixed-integer optimization

Today, we learned to:

- **Define** mixed-integer optimization problems
- **Model** logical relationships with integer variables and constraints
- **Analyze** relaxations and formulations

References

- D. Bertsimas & J. Tsitsiklis “Introduction to Linear Optimization”
 - Chapter 10: integer programming formulations
- R. Vanderbei “Linear Programming”
 - Chapter 23: Integer programming

Next lecture

- Integer optimization algorithms