

# **ORF307 – Optimization**

## **9. Geometry and polyhedra**

# Ed Forum

# Today's lecture

## Geometry and polyhedra

- Simple example
- Polyhedra
- Corners: extreme points, vertices, basic feasible solutions
- Constructing basic solutions
- Existence and optimality of extreme points

# A simple example

minimize  $c^T x$   
subject to  $-1/2 \leq x_1 \leq 2$   
 $-1/2 \leq x_2 \leq 2$   
 $x_1 + x_2 \leq 2$

**What kind of optimal solutions do we get?**

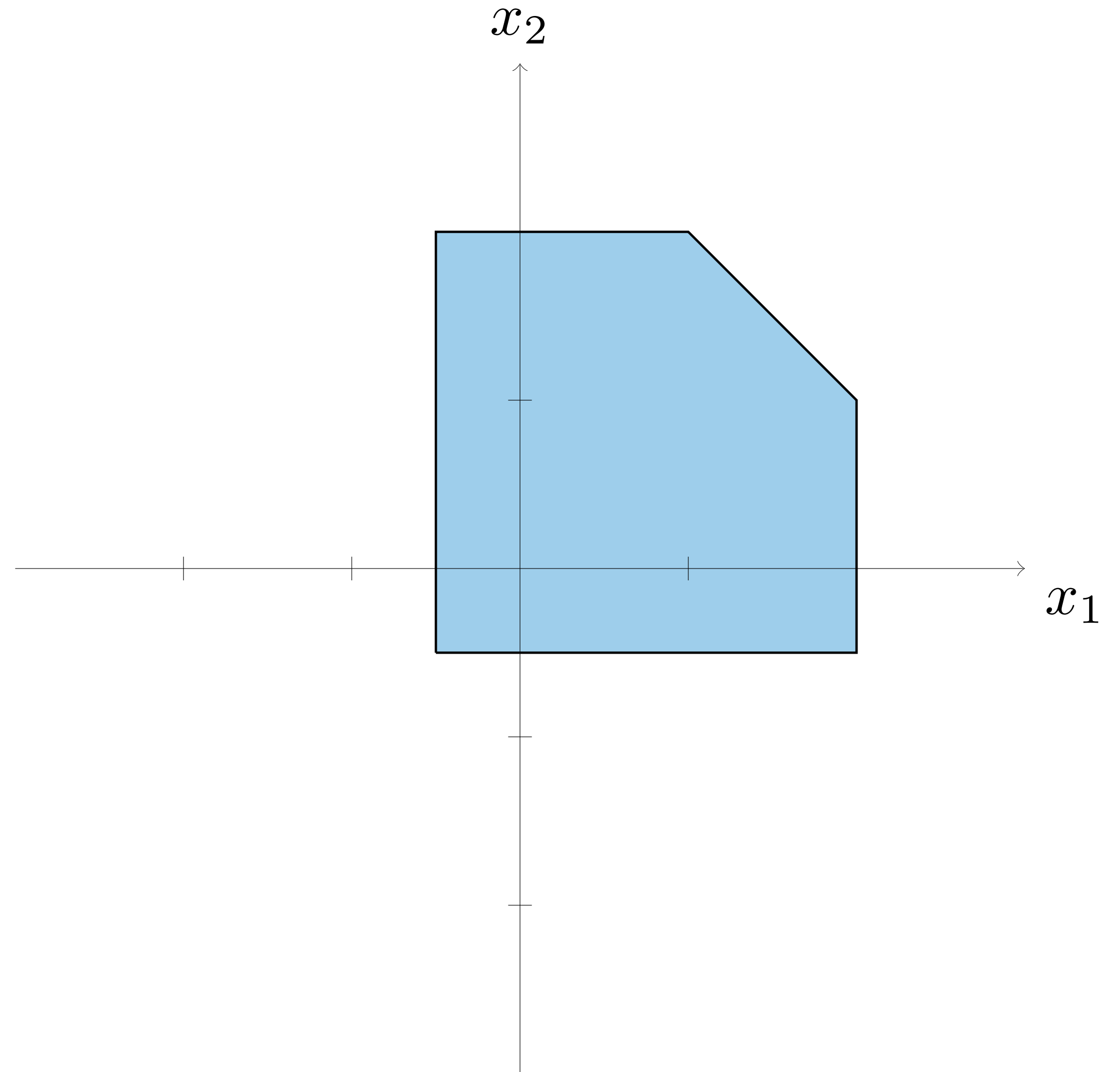

# A simple example

minimize  $c^T x$   
subject to  $-1/2 \leq x_1 \leq 2$   
 $-1/2 \leq x_2 \leq 2$   
 $x_1 + x_2 \leq 2$

Suppose  $c = (1, 1)$

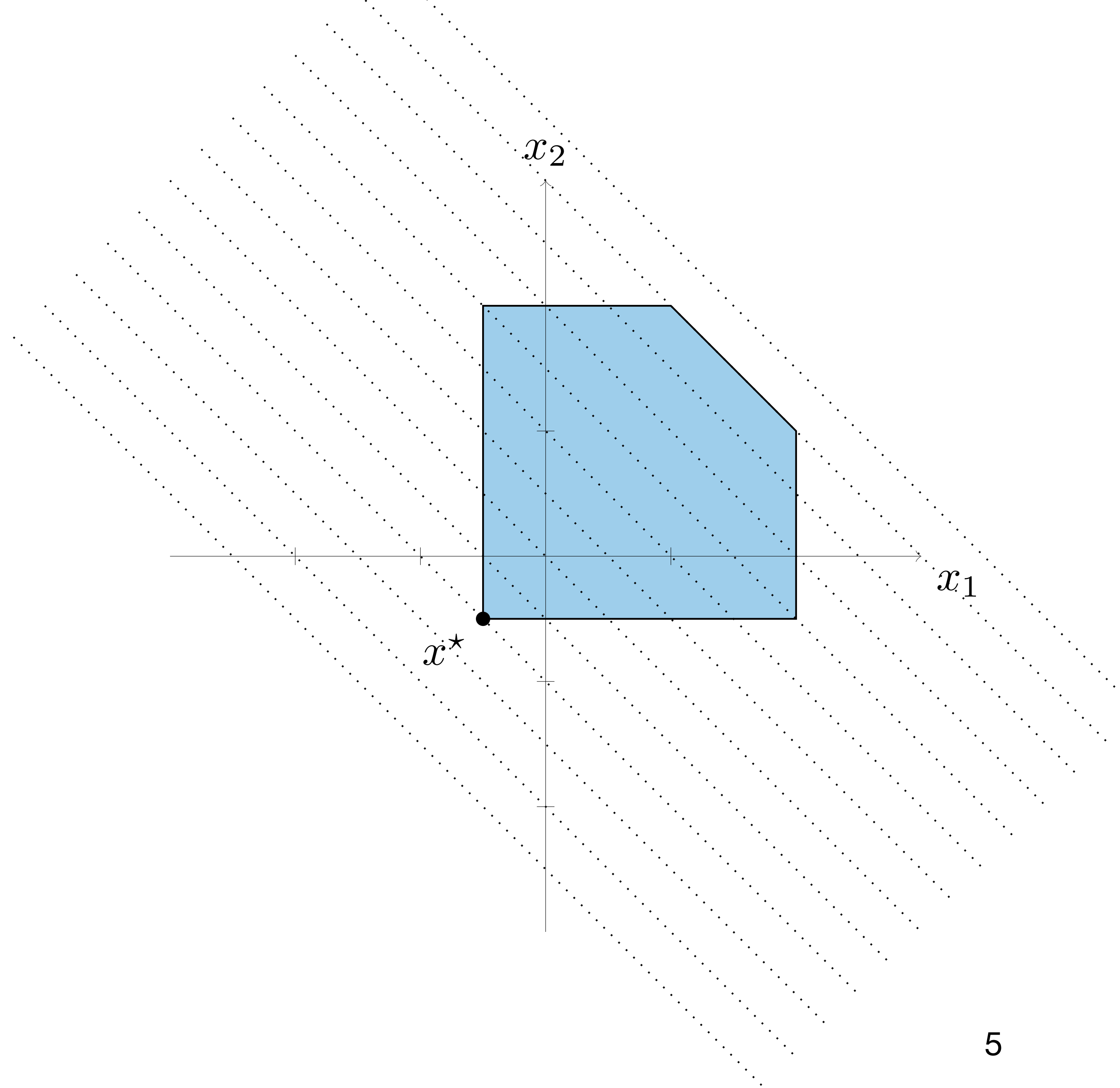

# A simple example

minimize  $c^T x$   
subject to  $-1/2 \leq x_1 \leq 2$   
 $-1/2 \leq x_2 \leq 2$   
 $x_1 + x_2 \leq 2$

Suppose  $c = (1, -1)$

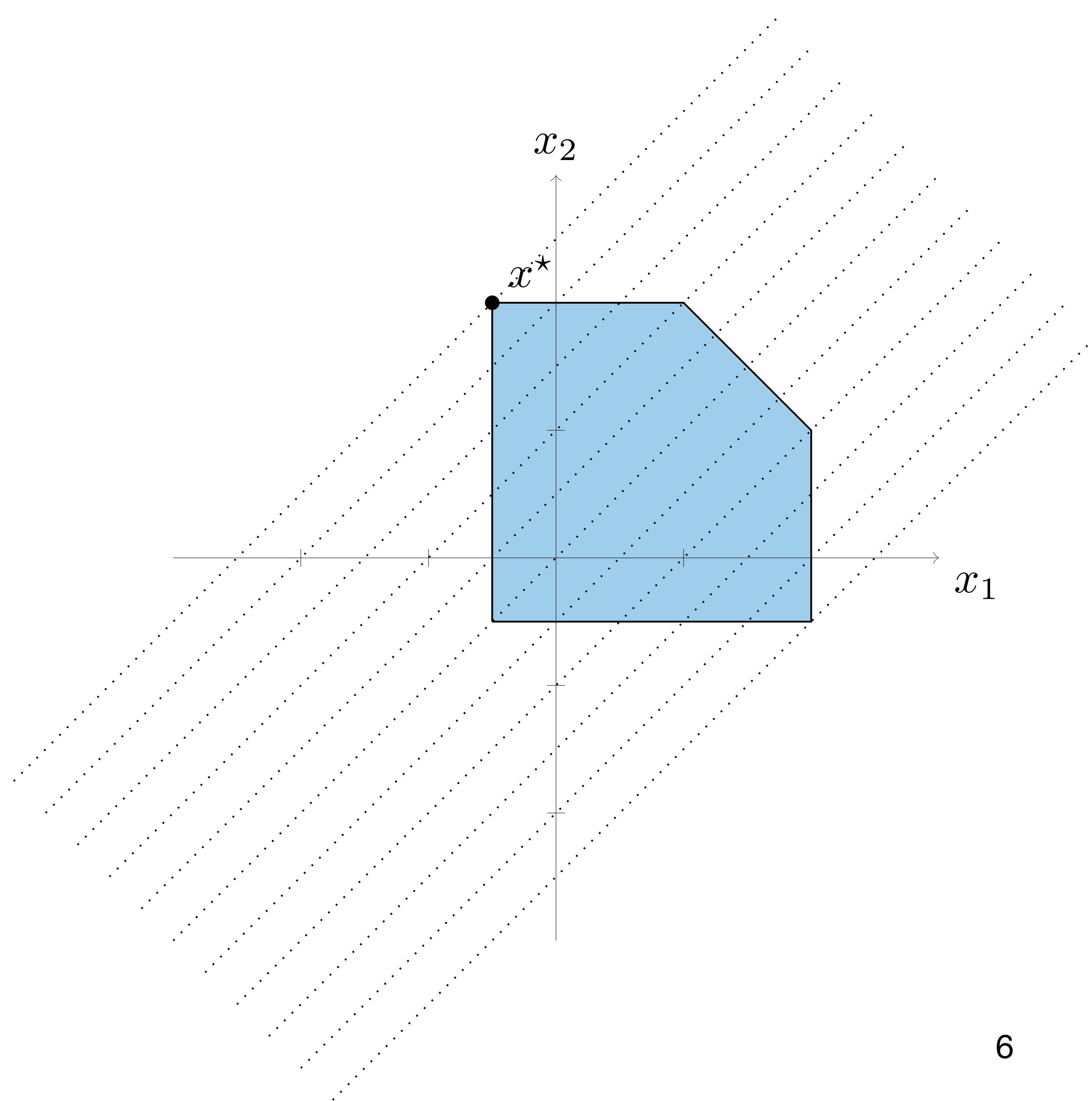

# A simple example

minimize  $c^T x$   
subject to  $-1/2 \leq x_1 \leq 2$   
 $-1/2 \leq x_2 \leq 2$   
 $x_1 + x_2 \leq 2$

Suppose  $c = (-1, -1)$

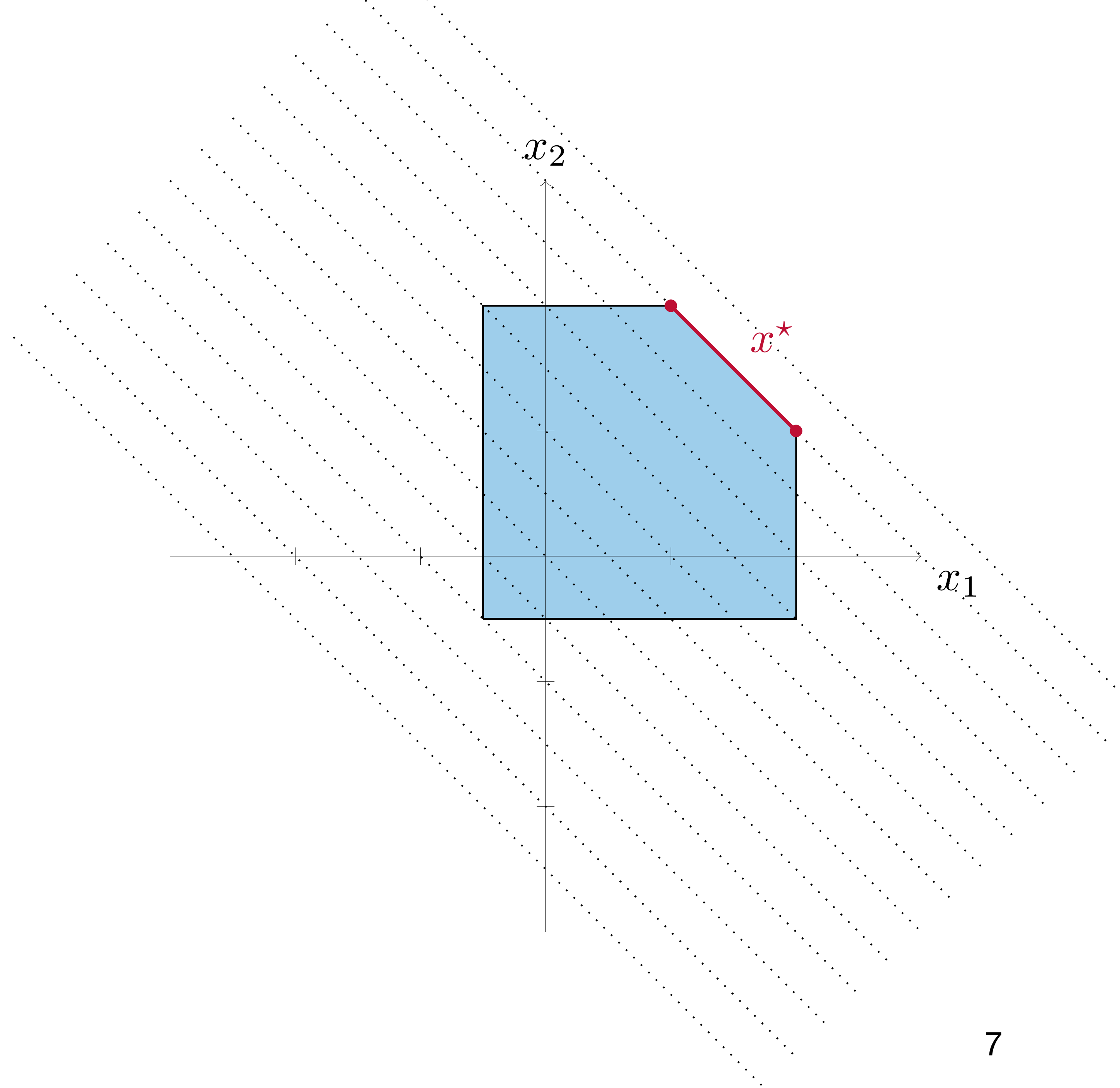

# Polyhedra and linear algebra



# Hyperplanes and halfspaces

## Definitions

### Hyperplane

$$\{x \mid a^T x = b\}$$

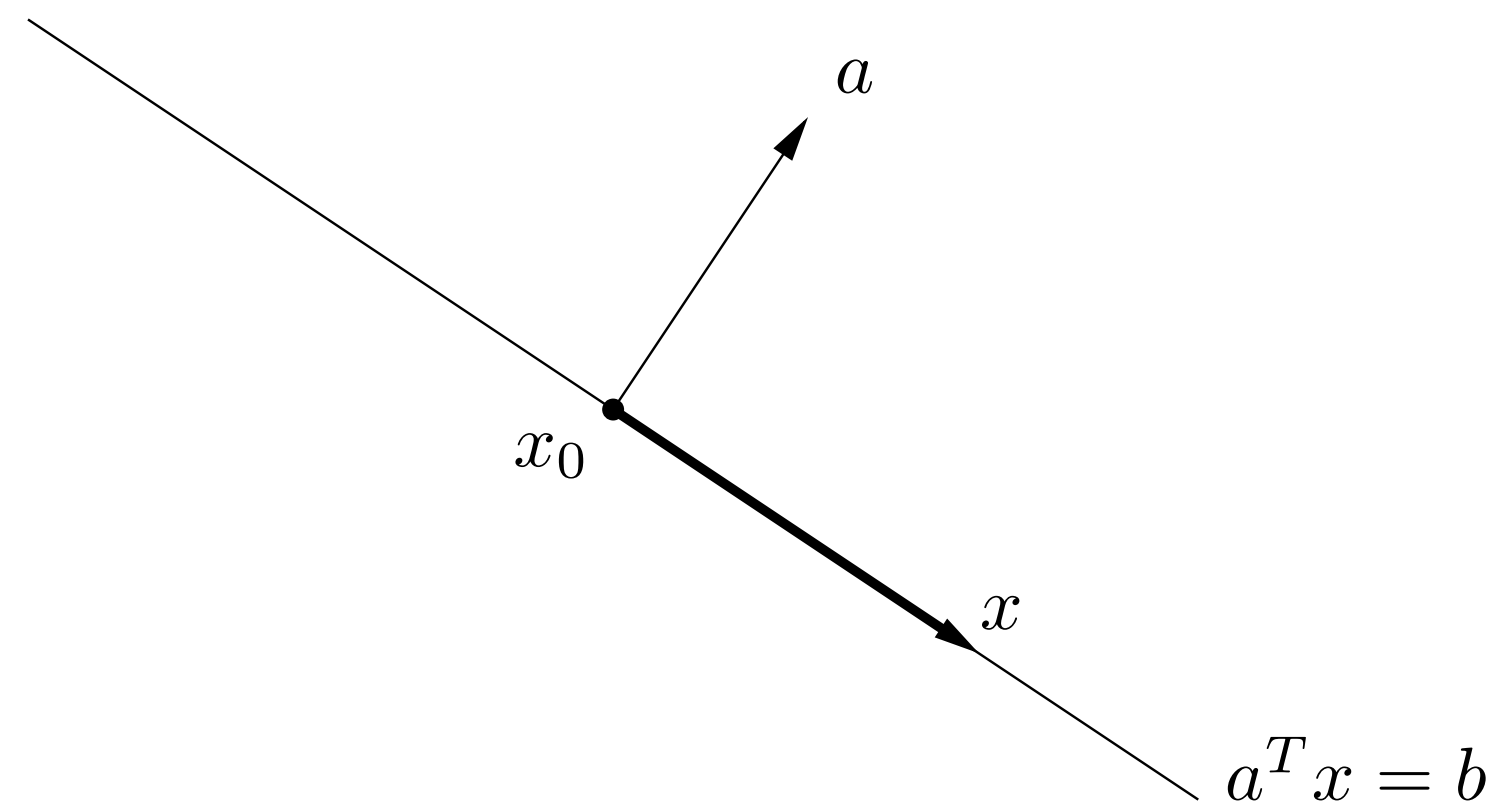

### Halfspace

$$\{x \mid a^T x \leq b\}$$

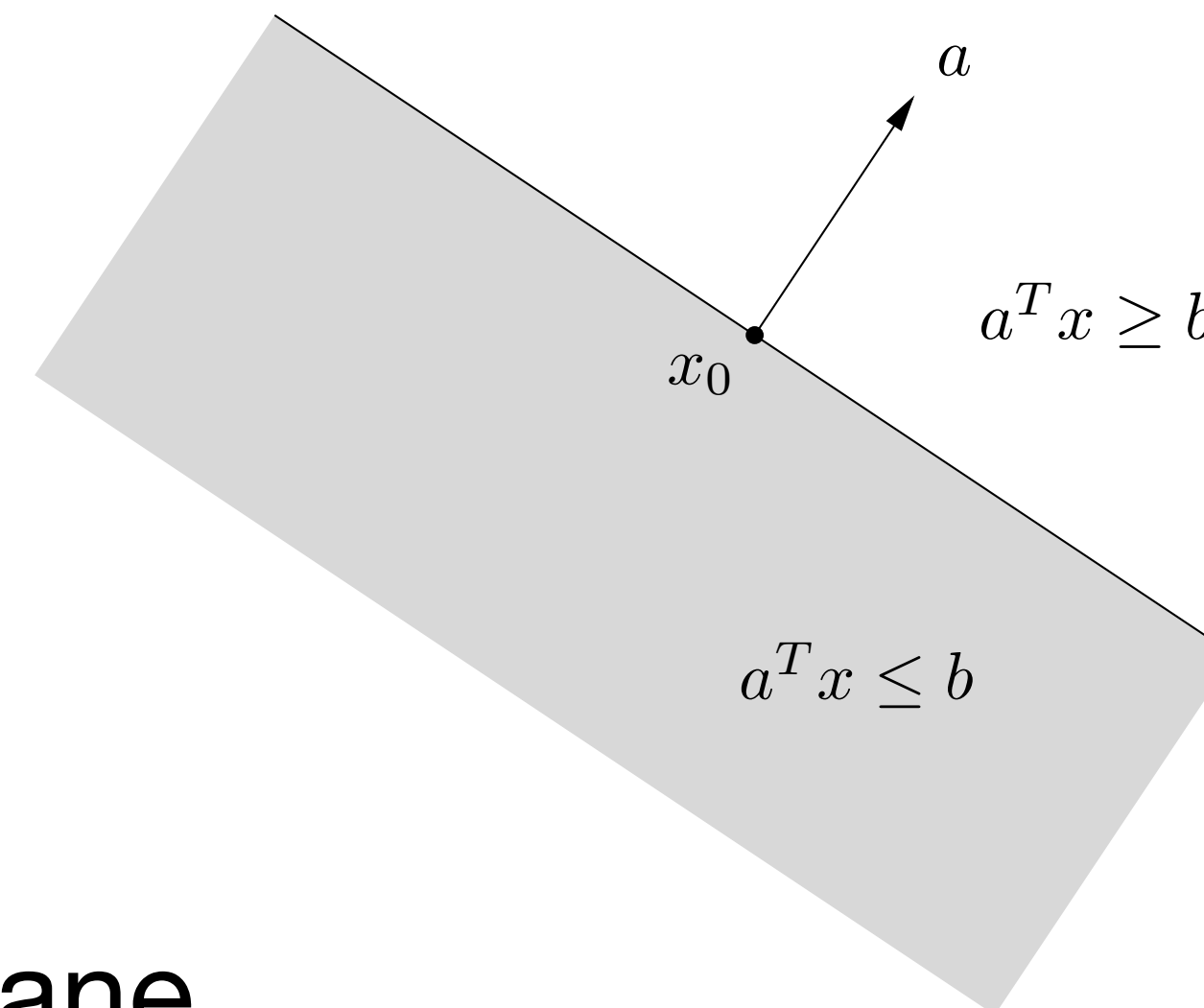

- $x_0$  is a specific point in the hyperplane
- For any  $x$  in the hyperplane defined by  $a^T x = b$ ,  $x - x_0 \perp a$
- The halfspace determined by  $a^T x \leq b$  extends in the direction of  $-a$

# Polyhedron

## Definition

$$P = \{x \mid a_i^T x \leq b_i, \quad i = 1, \dots, m\} = \{x \mid Ax \leq b\}$$

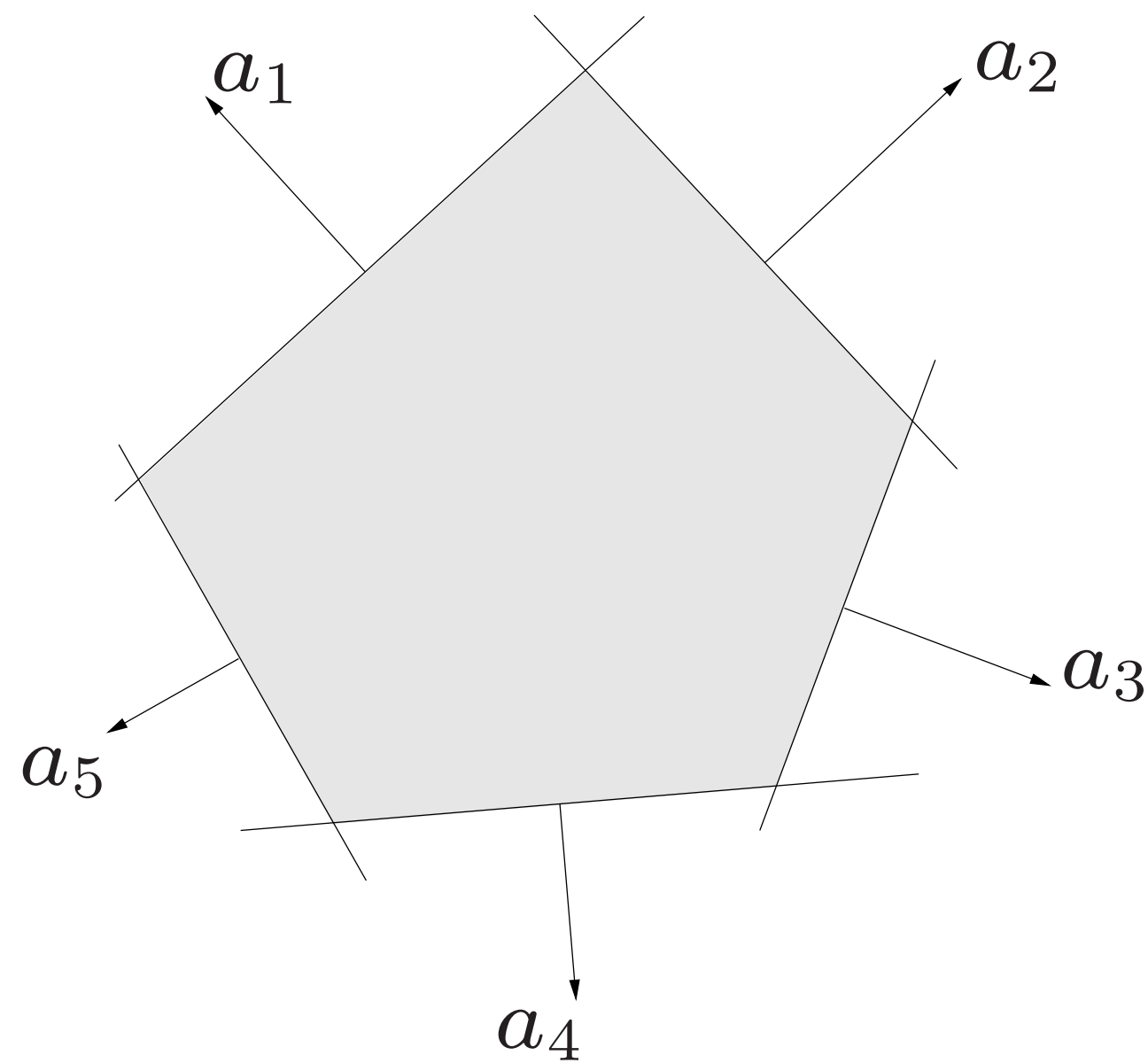

- Intersection of finite number of halfspaces
- Can include equalities

# Polyhedron

## Example

$$P = \{x \mid a_i^T x \leq b_i, \quad i = 1, \dots, m\} = \{x \mid Ax \leq b\}$$

$$\begin{array}{ll} \text{minimize} & c^T x \\ \text{subject to} & x_1 \leq 2 \\ & x_2 \leq 2 \\ & x_1 \geq -1/2 \\ & x_2 \geq -1/2 \\ & x_1 + x_2 \leq 2 \end{array}$$

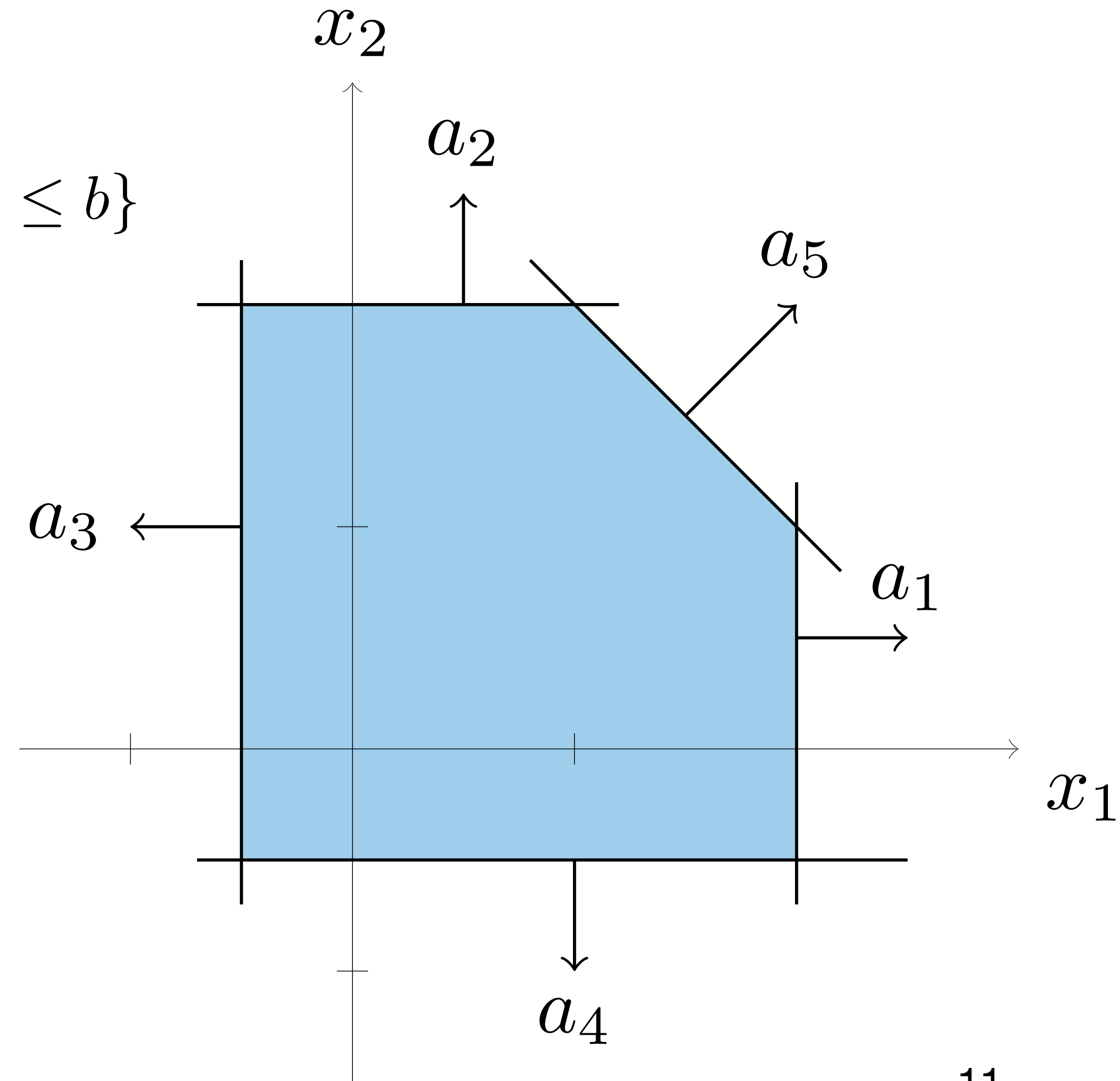

# Convex set

## Definition

For any  $x, y \in C$  and any  $\alpha \in [0, 1]$

$$\alpha x + (1 - \alpha)y \in C$$

**Convex**

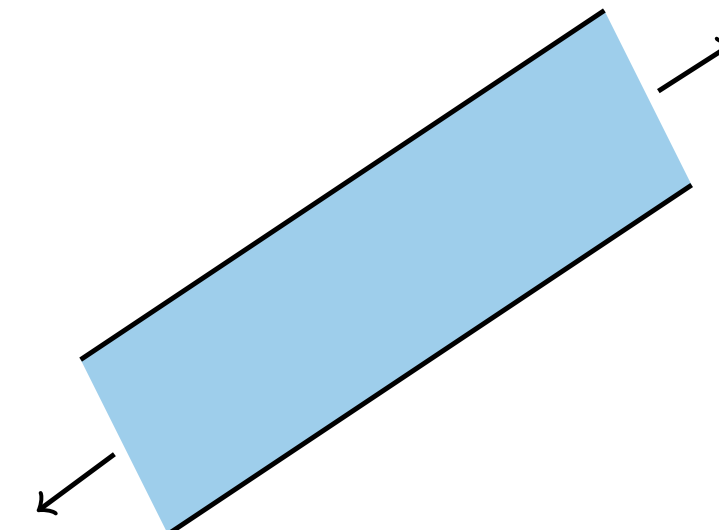
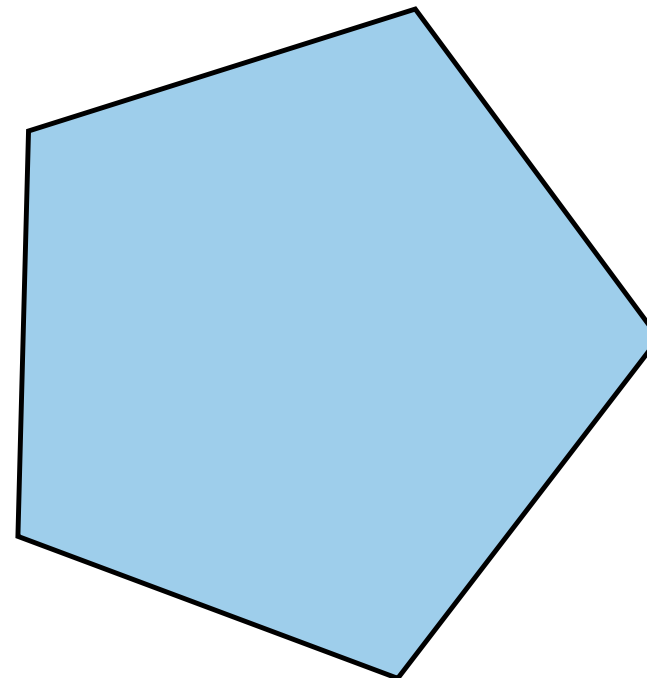
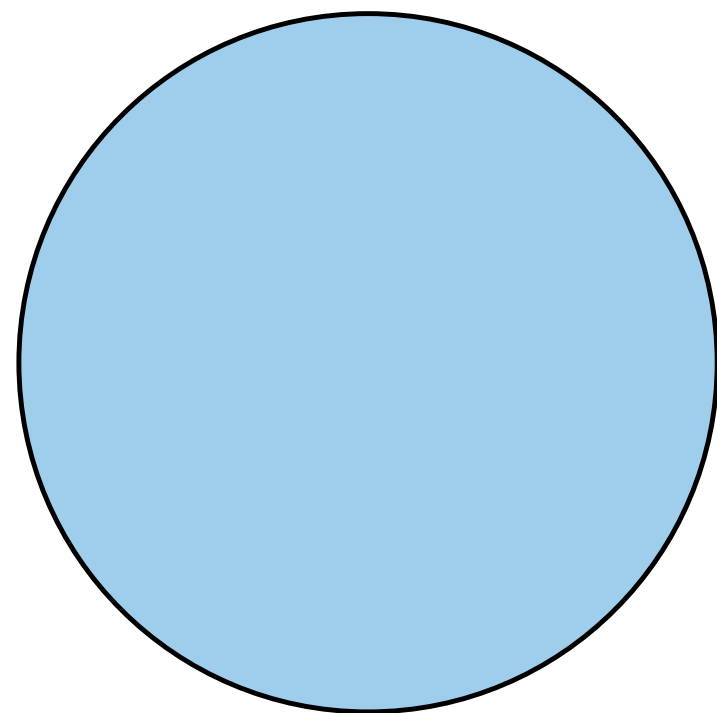

**Nonconvex**

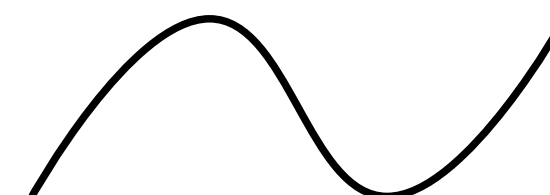
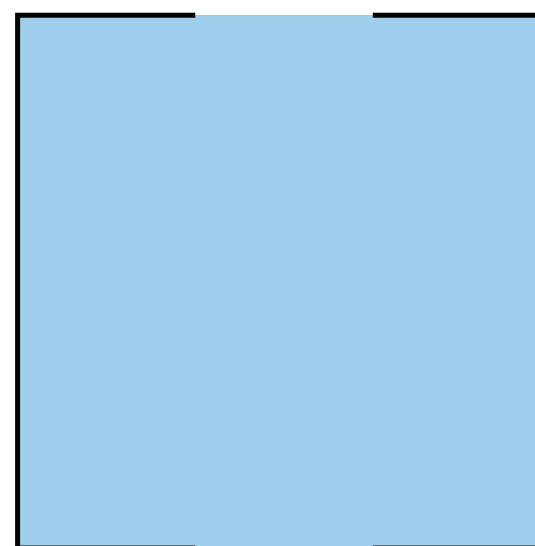
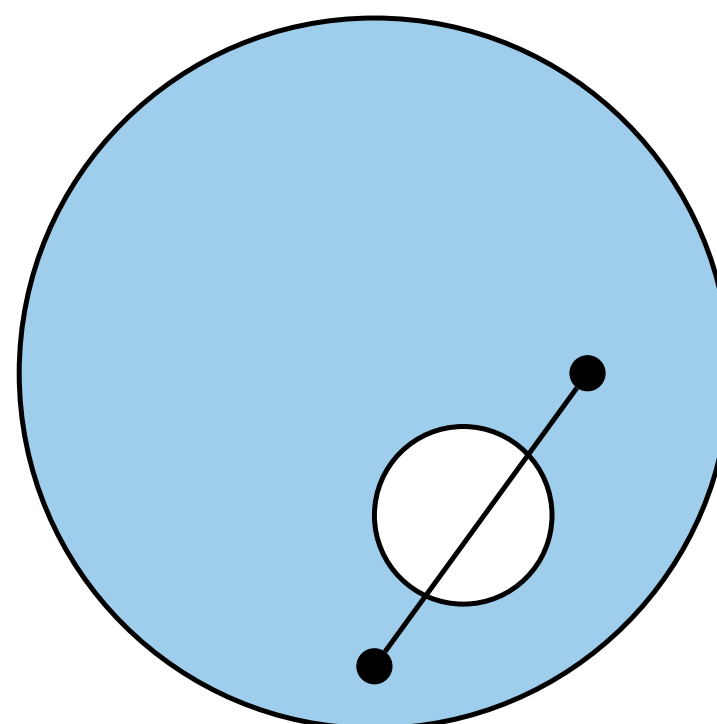

## Examples

- $\mathbf{R}^n$
- Hyperplanes
- Halfspaces
- Polyhedra

# Convex combinations

Ingredients :

- A collection of points  $C = \{x_1, \dots, x_k\}$
- A collection of non-negative weights  $\alpha_i$
- The weights  $\alpha_i$  sum to 1

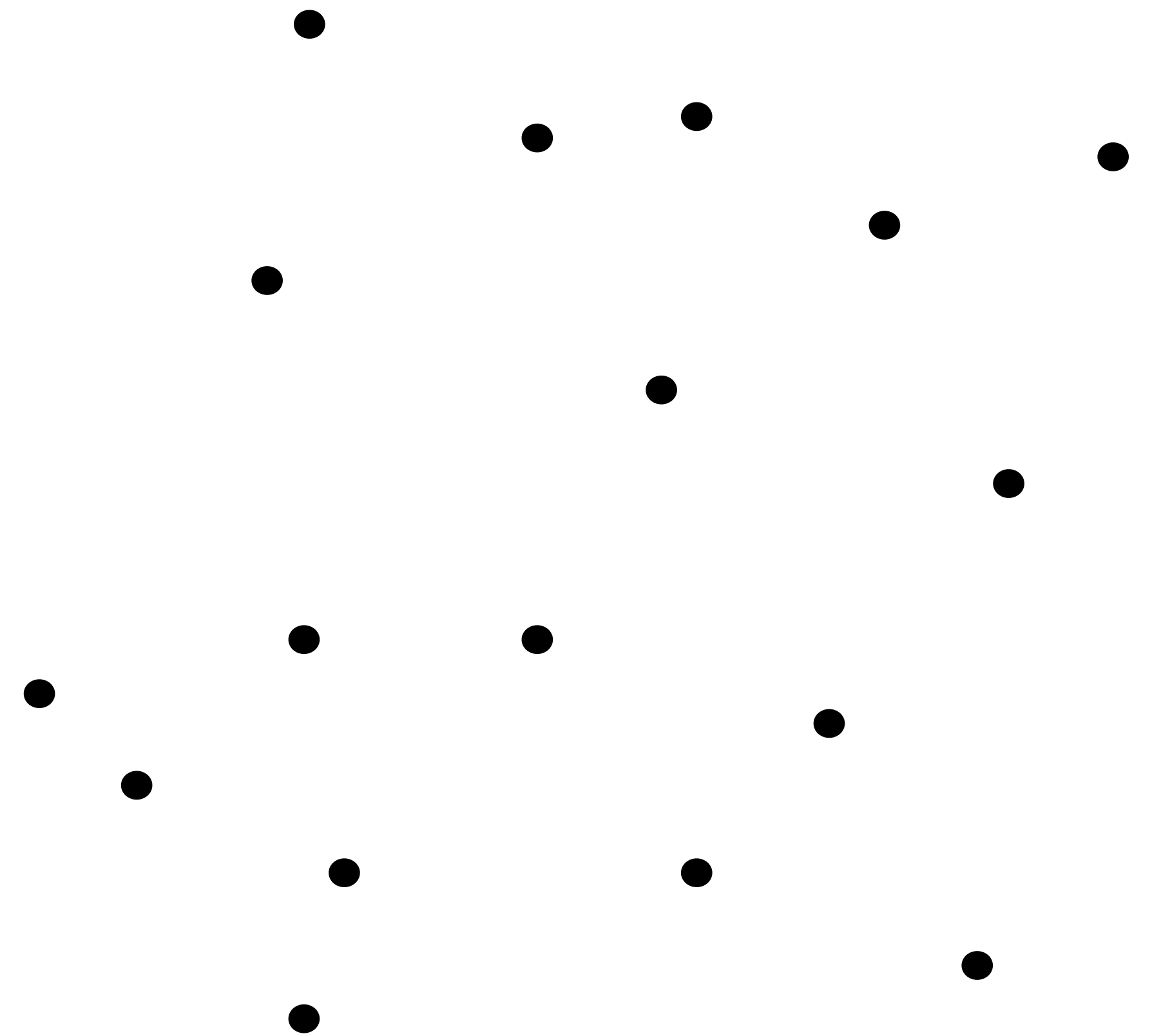

The vector  $v = \alpha_1 x_1 + \dots + \alpha_k x_k$  is a **convex combination** of the points.

# Convex hull

The **convex hull** is the set of all possible convex combinations of the points.

$\text{conv } C =$

$$\left\{ \sum_{i=1}^n \alpha_i x_i \mid \alpha_i \geq 0, i = 1, \dots, n, \mathbf{1}^T \alpha = 1 \right\}$$

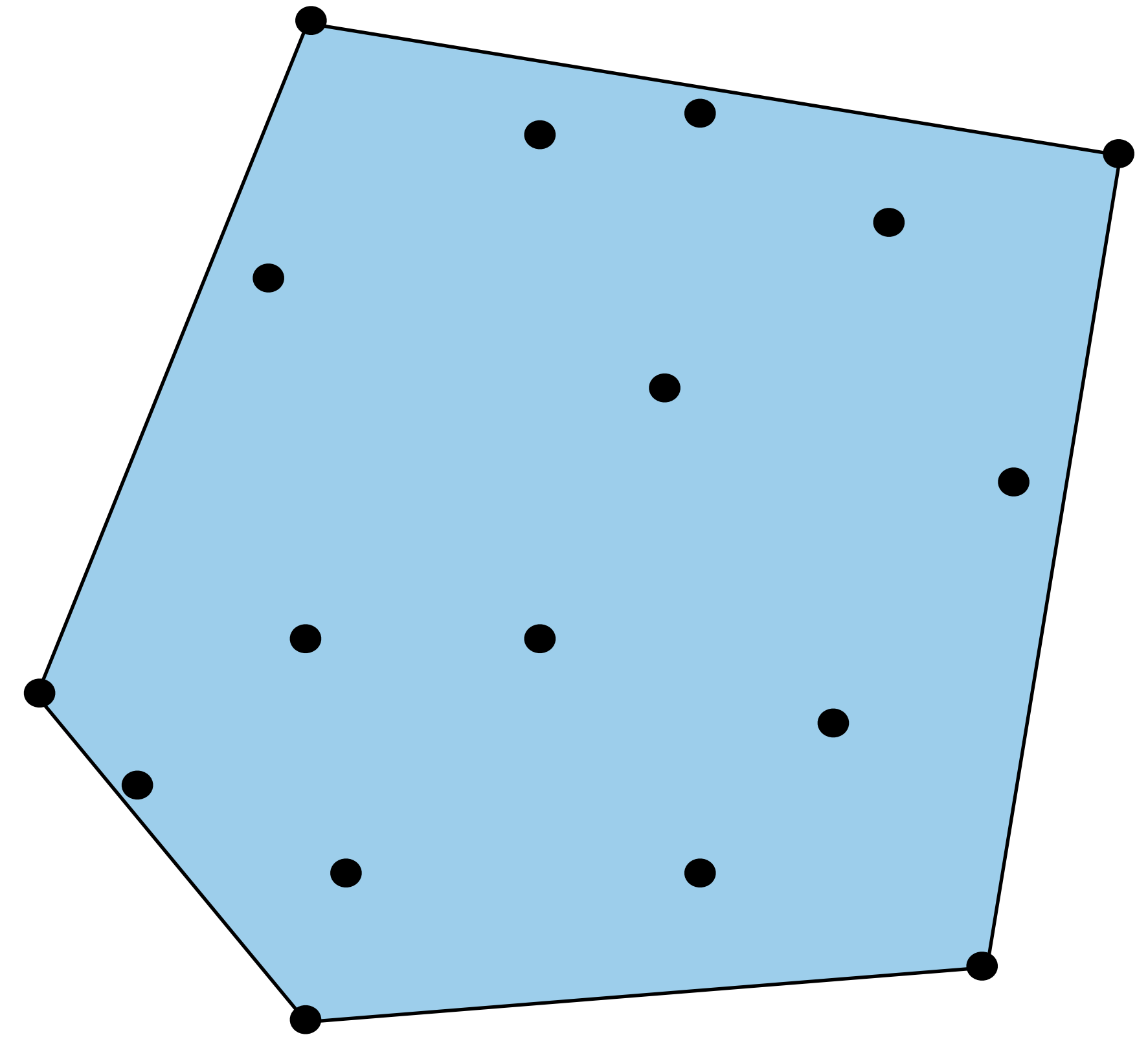

**Corners**

# Extreme points

## Definition:

An **extreme point** of a set is one not on a straight line between any other points in the set.

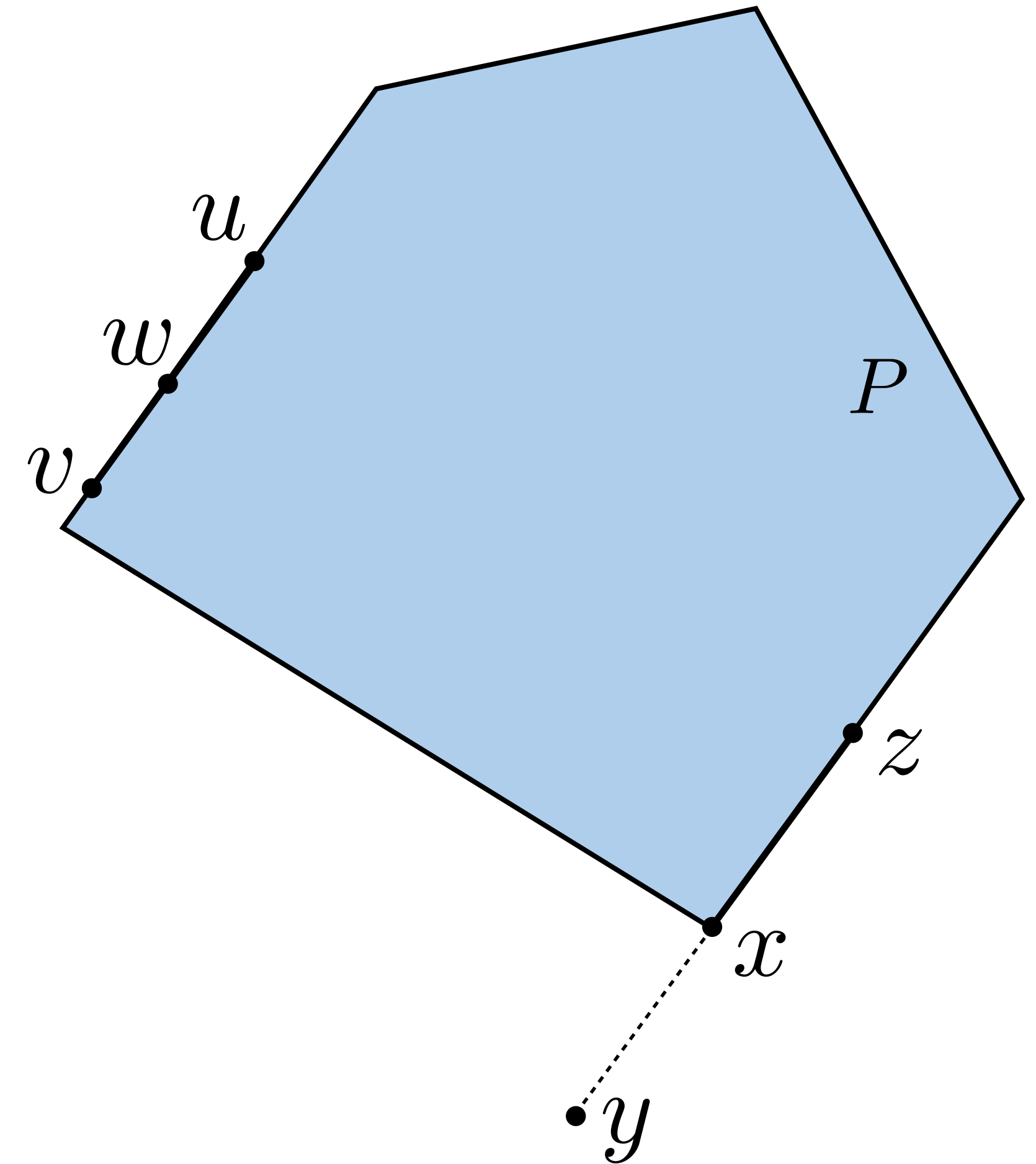

## More formal definition:

The point  $x \in P$  is an **extreme point** of  $P$  if

$\nexists y, z \in P$  ( $y \neq x, z \neq x$ ) and  $\alpha \in [0, 1]$  such that  $x = \alpha y + (1 - \alpha)z$



# Extreme points

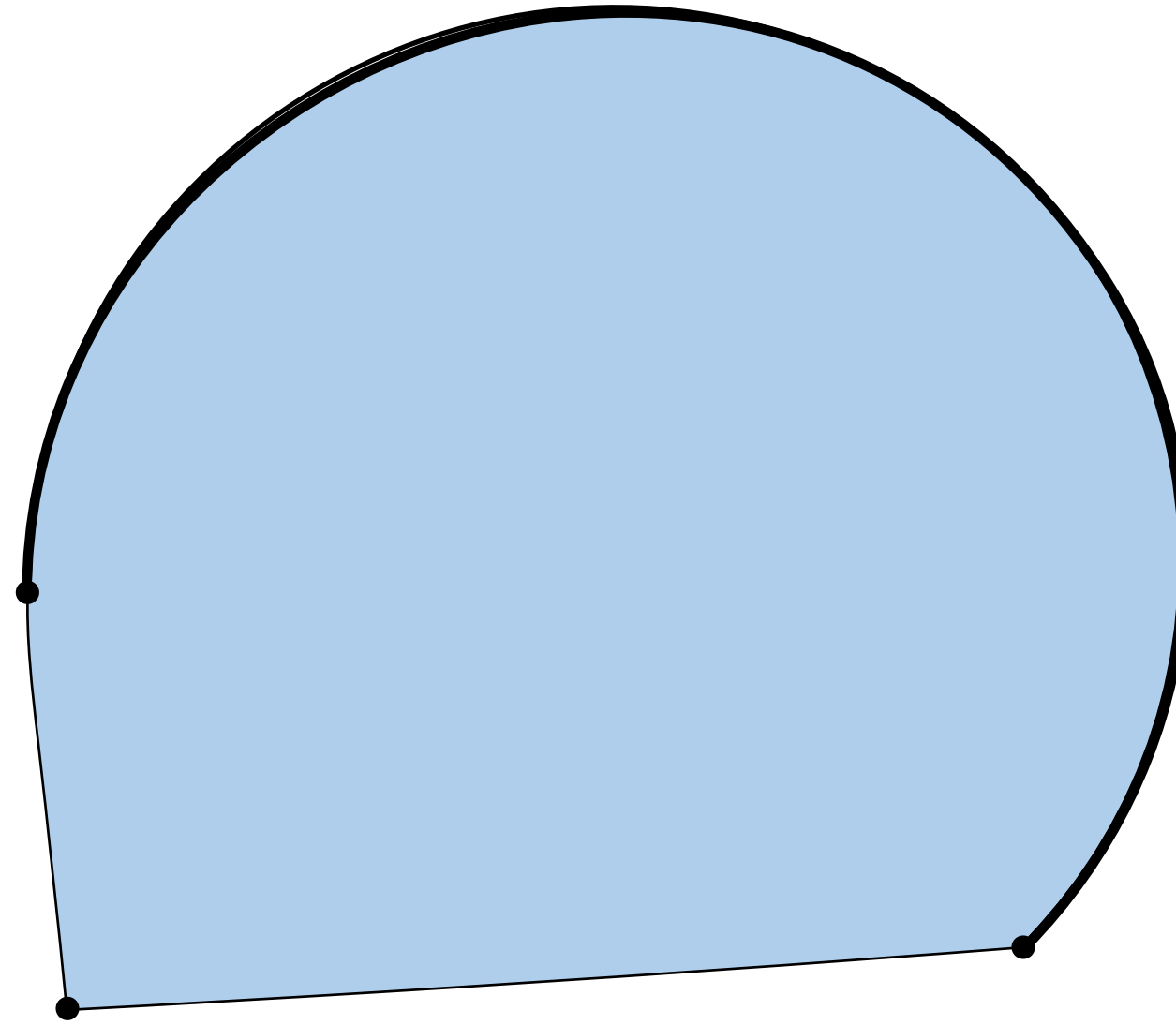

- General convex sets can have an infinite number of extreme points
- **Polyhedra** are convex sets with a finite number of extreme points

# Vertices

The point  $x \in P$  is a **vertex** if  $\exists c$  such that  $x$  is the unique optimum of

$$\begin{array}{ll} \text{minimize} & c^T y \\ \text{subject to} & y \in P \end{array}$$

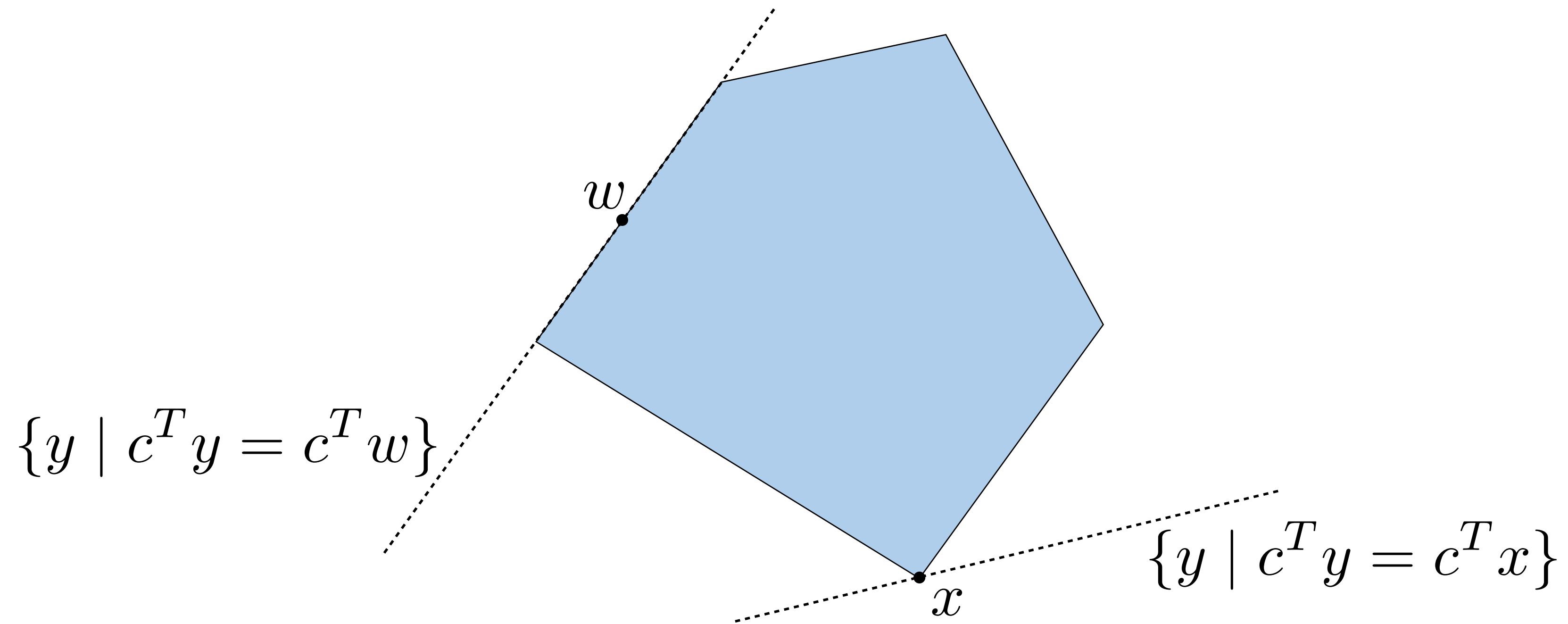

# Basic feasible solution

Assume we have a polytope  $P = \{x \mid a_i^T x \leq b_i, \quad i = 1, \dots, m\}$

**Active constraints at  $\bar{x}$**

$$\mathcal{I}(\bar{x}) = \{i \in \{1, \dots, m\} \mid a_i^T \bar{x} = b_i\}$$

**Basic feasible solution  $\bar{x} \in P$**

$\{a_i \mid i \in \mathcal{I}(\bar{x})\}$  has  $n$  linearly independent vectors

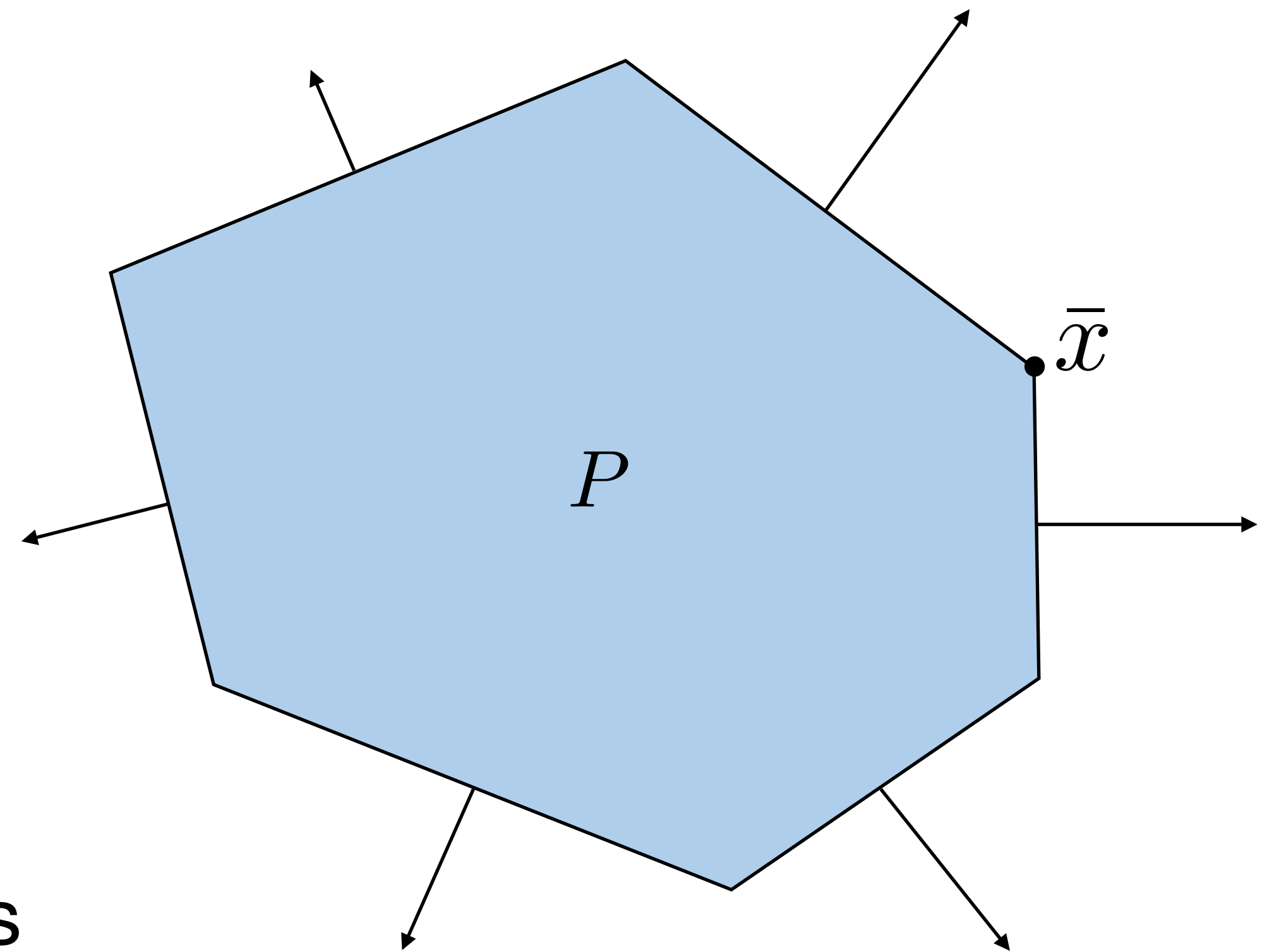

# Degenerate basic feasible solutions

A solution  $\bar{x}$  is **degenerate** if  $|\mathcal{I}(\bar{x})| > n$

**True or False?**

	Basic	Feasible	Degenerate
$x$			
$y$			
$z$			

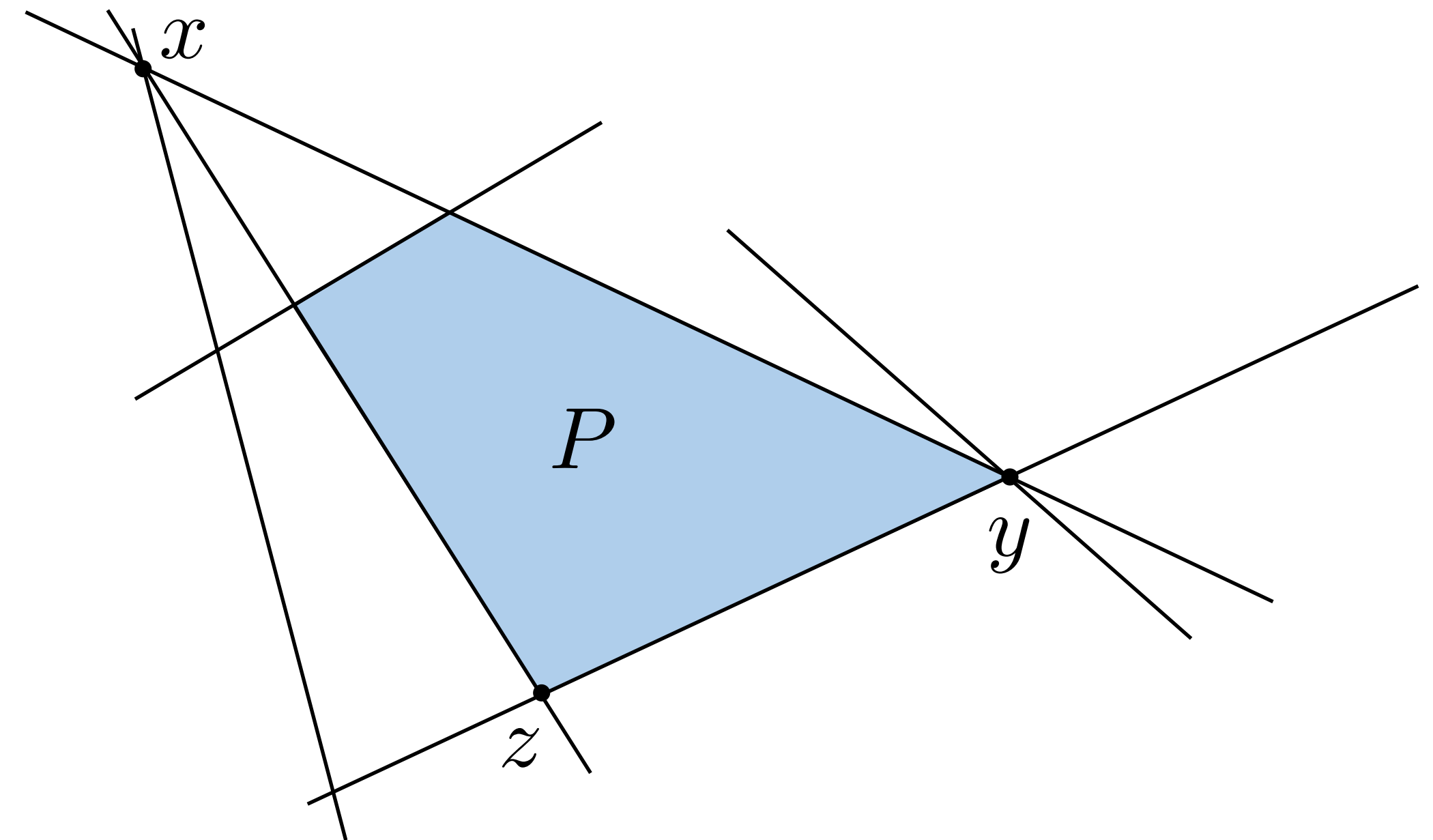

# An Equivalence Theorem

Given a nonempty polyhedron  $P = \{x \mid Ax \leq b\}$

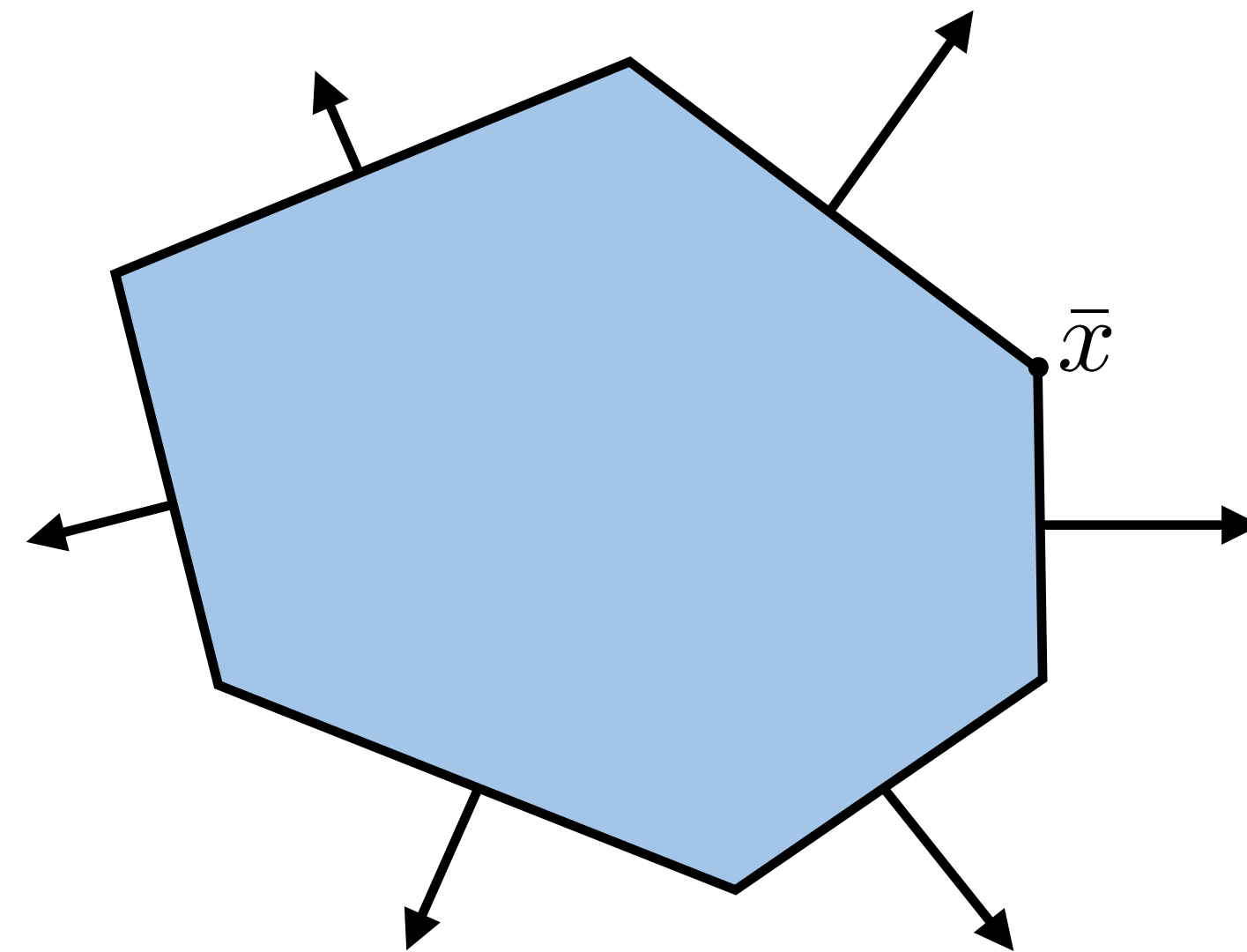

$x$  is a **vertex**  $\iff x$  is an **extreme point**  $\iff x$  is a **basic feasible solution**

# Equivalent theorem proof

## Vertex $\rightarrow$ Extreme point

If  $x$  is a vertex,  $\exists c$  such that  $c^T x < c^T y, \quad \forall y \in P, y \neq x$

Let's assume  $x$  is not an extreme point:

$\exists y, z \neq x$  such that  $x = \lambda y + (1 - \lambda)z$

Since  $x$  is a vertex,  $c^T x < c^T y$  and  $c^T x < c^T z$

Therefore,  $c^T x = \lambda c^T y + (1 - \lambda)c^T z > \lambda c^T x + (1 - \lambda)c^T x = c^T x$

$\implies$  **contradiction**



# Equivalent theorem proof

**Extreme point  $\rightarrow$  Basic feasible solution**

(proof by contraposition)

Suppose  $x \in P$  is **not basic feasible solution**

$\{a_i \mid i \in \mathcal{I}(x)\}$  does not span  $\mathbf{R}^n$

$\exists d \in \mathbf{R}^n$  perpendicular to all of them:  $a_i^T d = 0, \quad \forall i \in \mathcal{I}(x)$

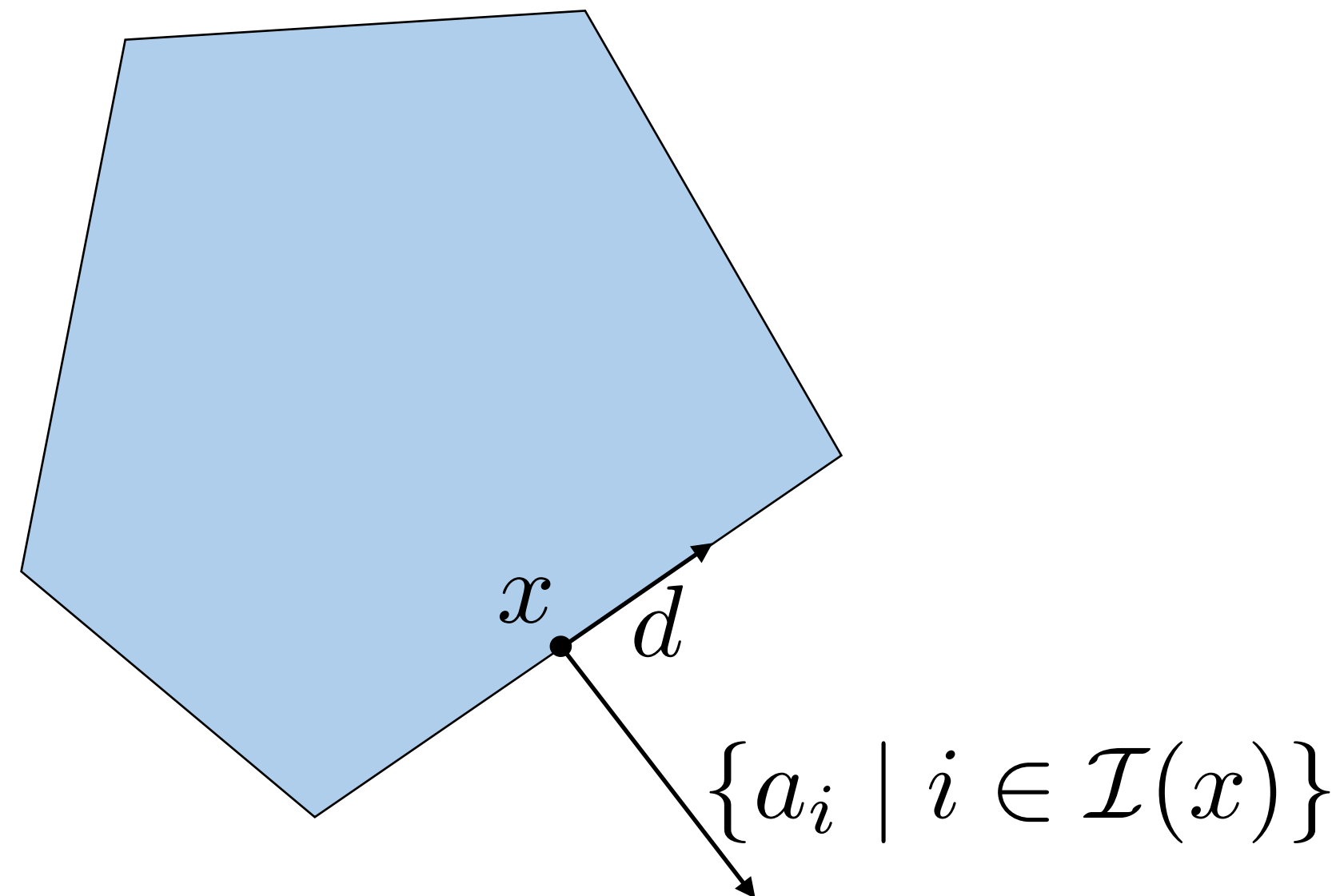

# Equivalent theorem proof

**Extreme point  $\rightarrow$  Basic feasible solution**

(proof by contraposition)

Suppose  $x \in P$  is **not basic feasible solution**

$\{a_i \mid i \in \mathcal{I}(x)\}$  does not span  $\mathbf{R}^n$

$\exists d \in \mathbf{R}^n$  perpendicular to all of them:  $a_i^T d = 0, \quad \forall i \in \mathcal{I}(x)$

Let  $\epsilon > 0$  and define  $y = x + \epsilon d$  and  $z = x - \epsilon d$

For  $i \in \mathcal{I}(x)$  we have  $a_i^T y = b_i$  and  $a_i^T z = b_i$

For  $i \notin \mathcal{I}(x)$  we have  $a_i^T x < b_i \Rightarrow a_i^T (x + \epsilon d) < b_i$  and  $a_i^T (x - \epsilon d) < b_i$

Hence,  $y, z \in P$  and  $x = \lambda y + (1 - \lambda)z$  with  $\lambda = 0.5$ .

$\implies x$  is **not an extreme point**





# Equivalent theorem proof

Extreme point  $\rightarrow$  Basic feasible solution

(proof by contraposition)

Suppose  $x \in P$  is not basic feasible solution

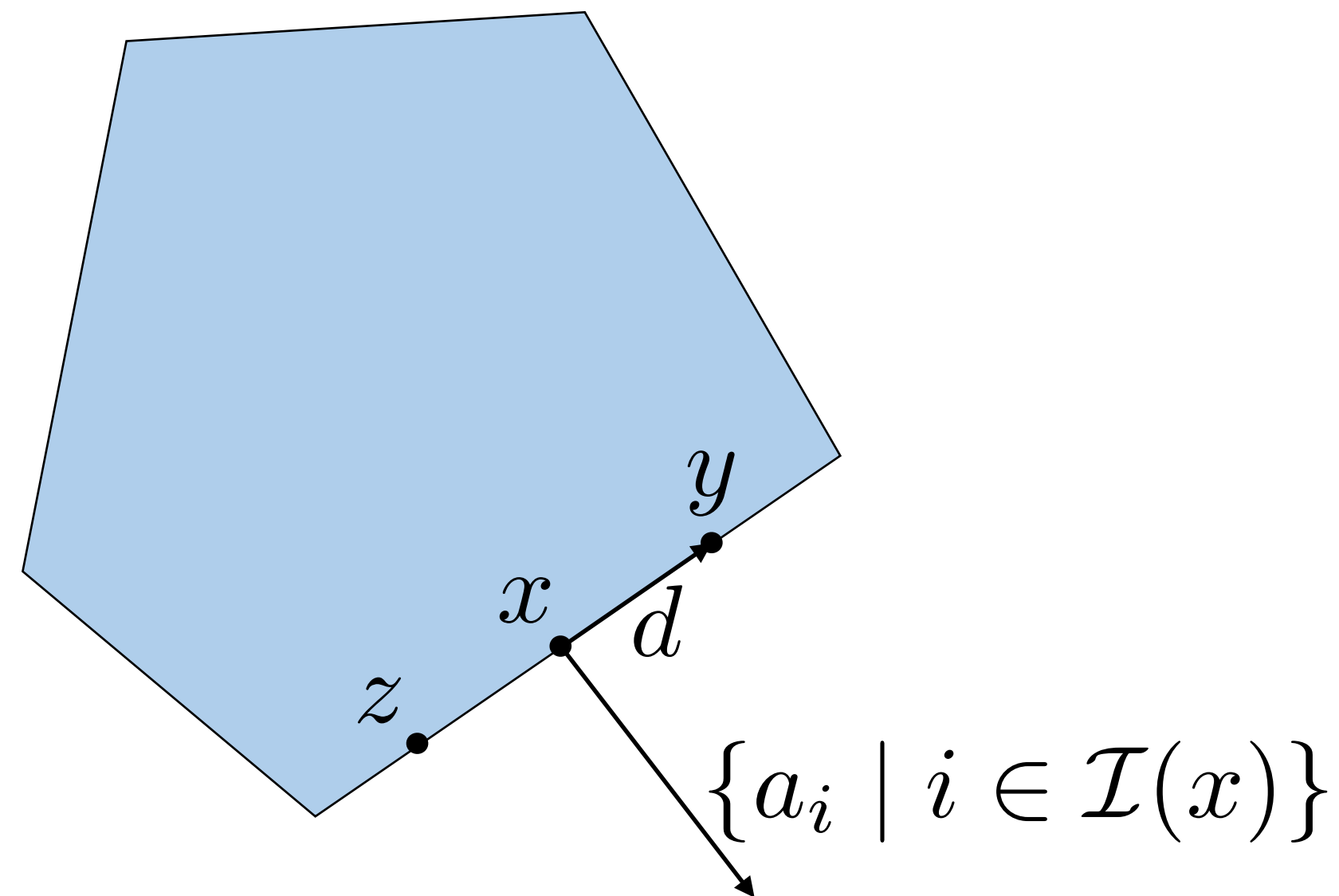

Hence,  $y, z \in P$  and  $x = \lambda y + (1 - \lambda)z$  with  $\lambda = 0.5$ .

$\implies x$  is not an extreme point



# Equivalence theorem proof

Basic feasible solution  $\rightarrow$  Vertex

Left as exercise

**Hint**

Define  $c = \sum_{i \in \mathcal{I}(x)} a_i$

# Constructing basic solutions

# 3D example

One equality ( $m = 1, n = 3$ )

$$\begin{aligned} &\text{minimize} && c^T x \\ &\text{subject to} && x_1 + x_2 + x_3 = 1 \\ &&& x_1, x_2, x_3 \geq 0 \end{aligned}$$

**Basic feasible solution**  $\bar{x}$  has  $n$   
linearly independent active constraints.



$n - m = 2$  inequalities have to be tight:  $x_i = 0$

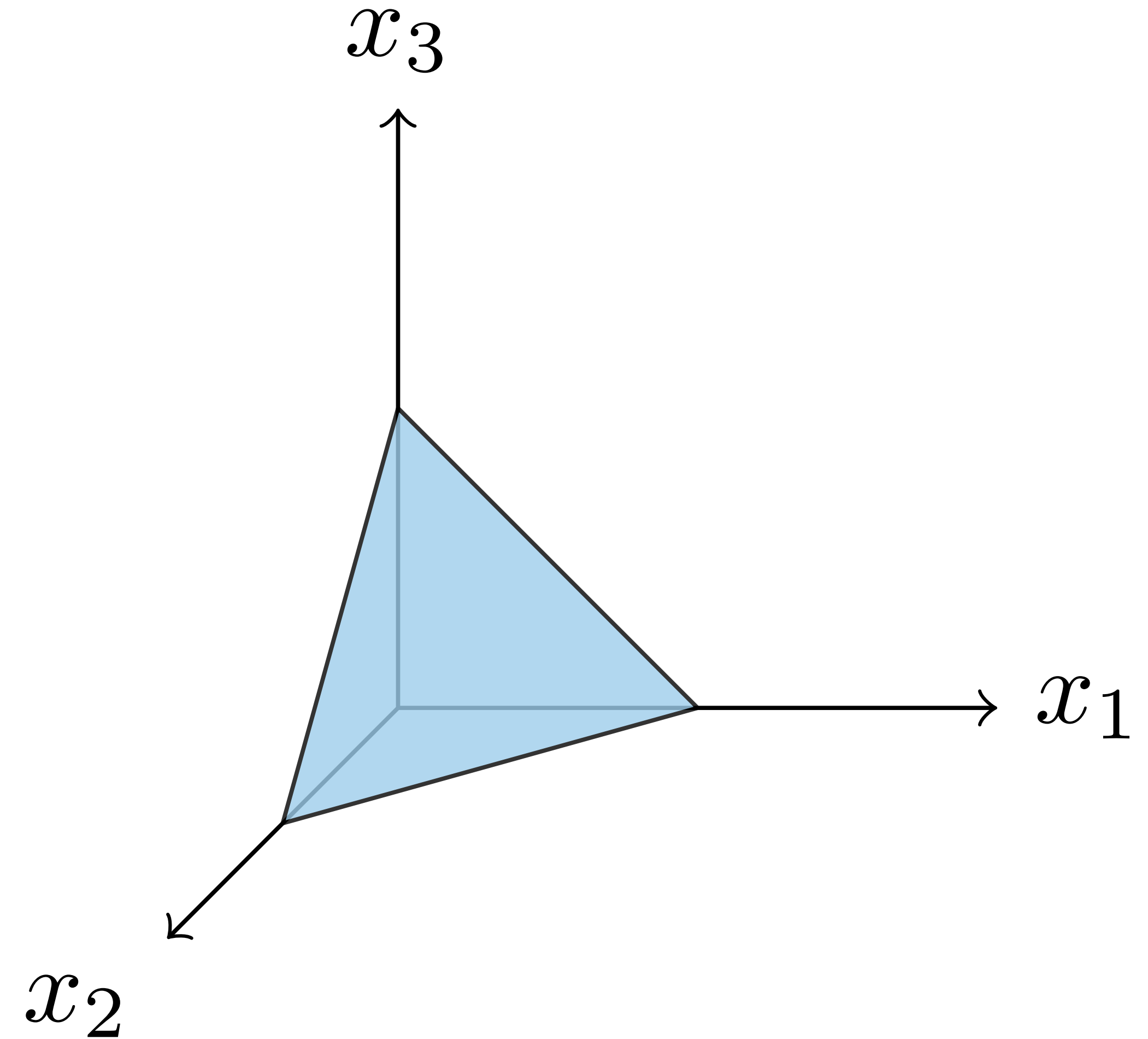

# 3D example

Two equalities ( $m = 2, n = 3$ )

minimize  $c^T x$

subject to  $x_1 + x_3 = 1$

$(1/2)x_1 + x_2 + (1/2)x_3 = 1$

$x_1, x_2, x_3 \geq 0$

**Basic feasible solution**  $\bar{x}$  has  $n$   
linearly independent active constraints.



$n - m = 1$  inequalities have to be tight:  $x_i = 0$

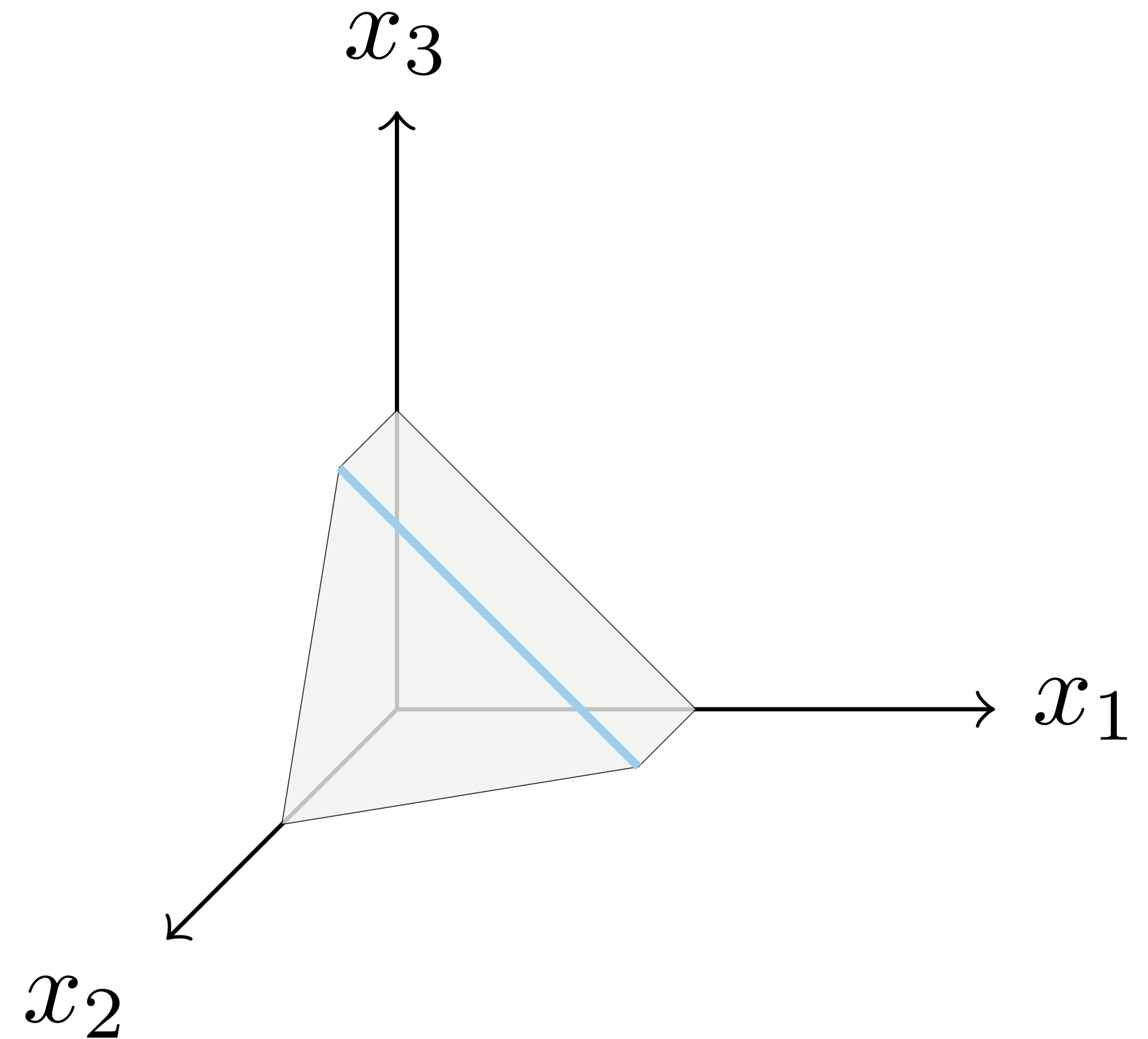

# 3D example

Three equalities ( $m = 3, n = 3$ )

minimize  $c^T x$

subject to  $x_1 + x_3 = 1$

$(1/2)x_1 + x_2 + (1/2)x_3 = 1$

$2x_1 = 1$

$x_1, x_2, x_3 \geq 0$

**Basic feasible solution**  $\bar{x}$  has  $n$   
linearly independent active constraints.



$n - m = 0$  inequalities have to be tight:  $x_i = 0$

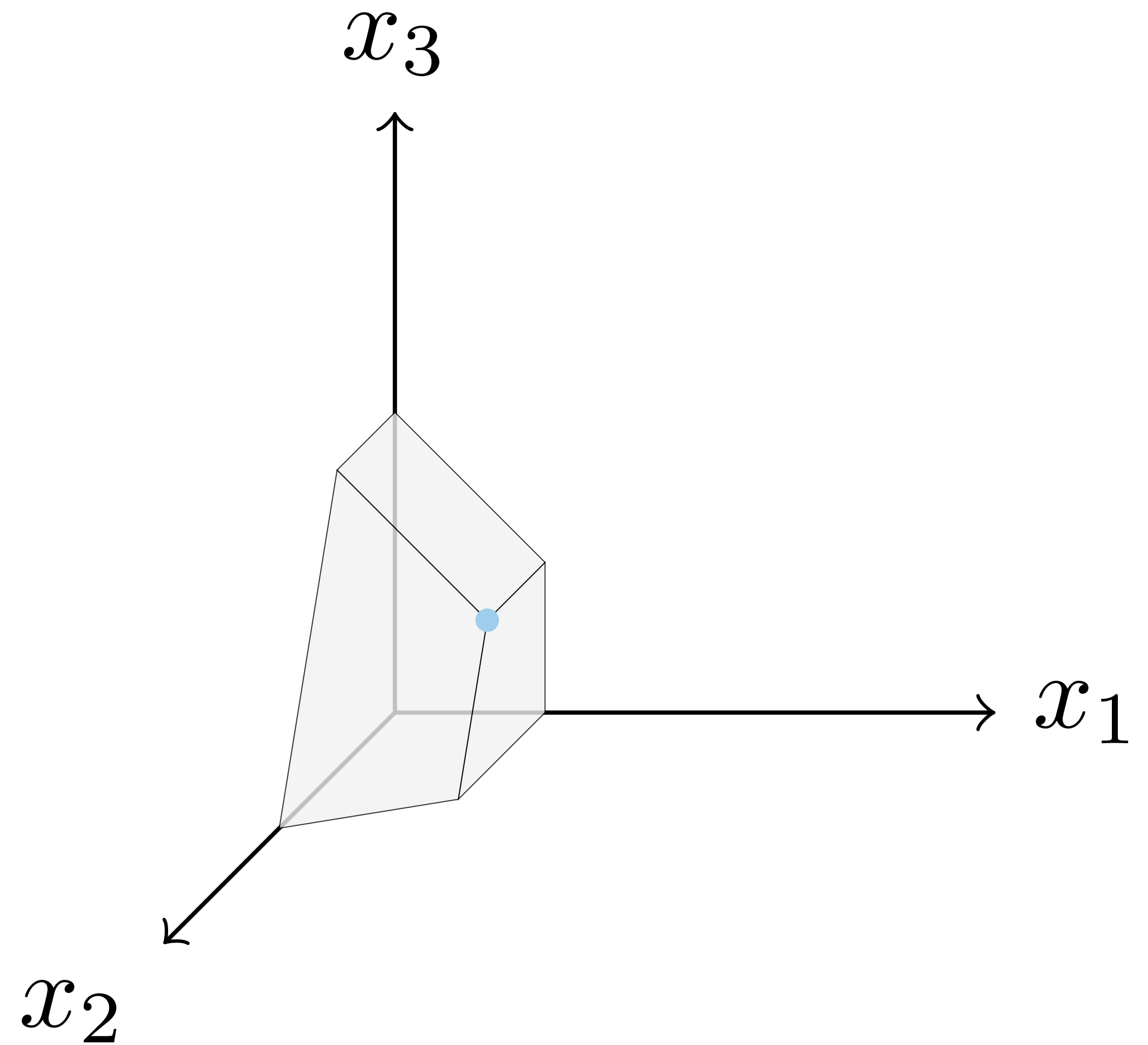

# Standard form polyhedra

## Standard form LP

$$\begin{array}{ll} \text{minimize} & c^T x \\ \text{subject to} & Ax = b \\ & x \geq 0 \end{array}$$

## Assumption

$A \in \mathbf{R}^{m \times n}$  has full row rank  $m \leq n$

## Interpretation

$P$  is an  $(n - m)$ -dimensional surface

## Standard form polyhedron

$$P = \{x \mid Ax = b, x \geq 0\}$$

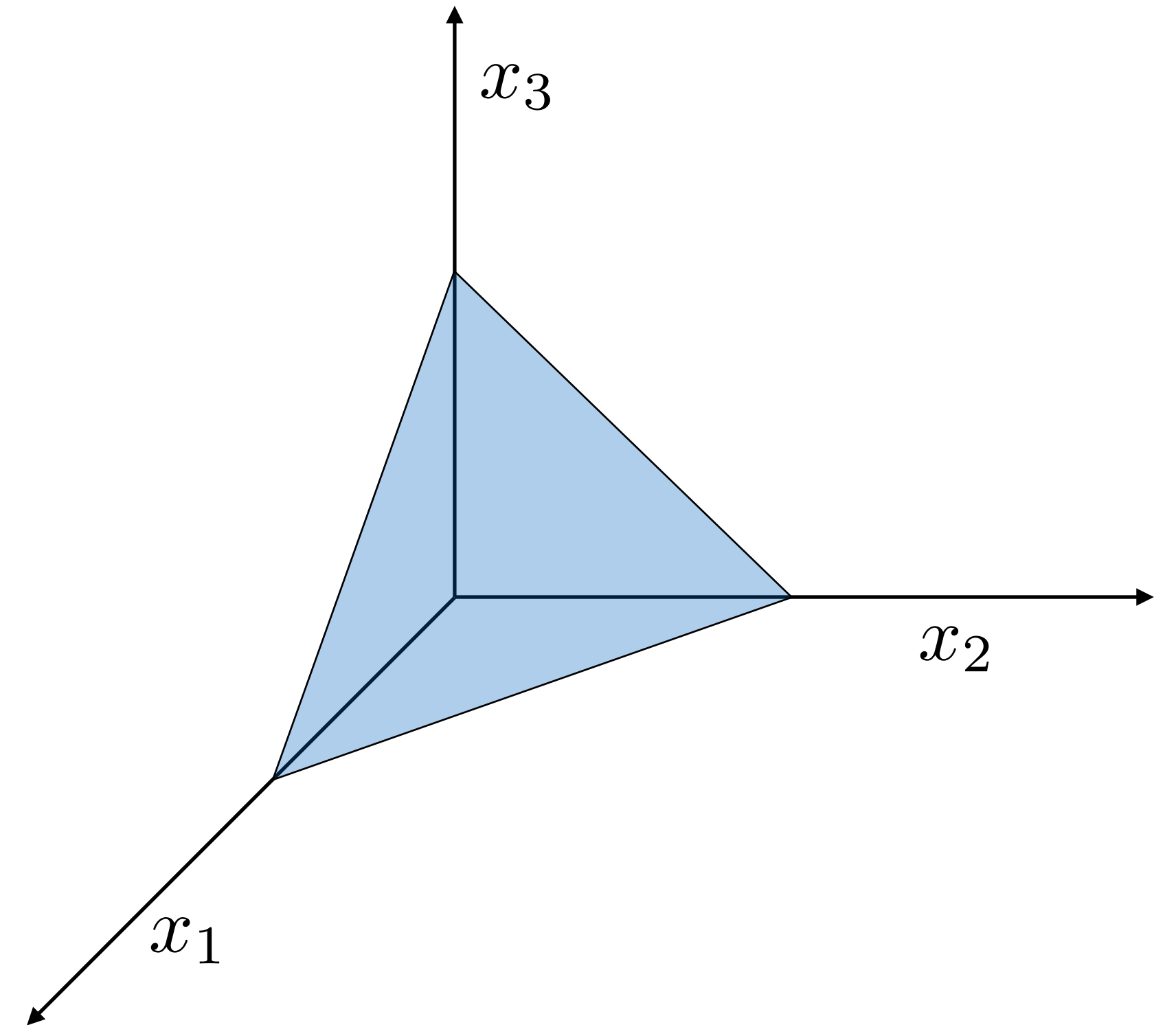

$$n = 3, m = 1$$

# Constructing a basic solution

Two equalities ( $m = 2, n = 3$ )

minimize  $c^T x$

subject to  $x_1 + x_3 = 1$

$(1/2)x_1 + x_2 + (1/2)x_3 = 1$

$x_1, x_2, x_3 \geq 0$

$n - m = 1$  inequalities have to be tight:  $x_i = 0$

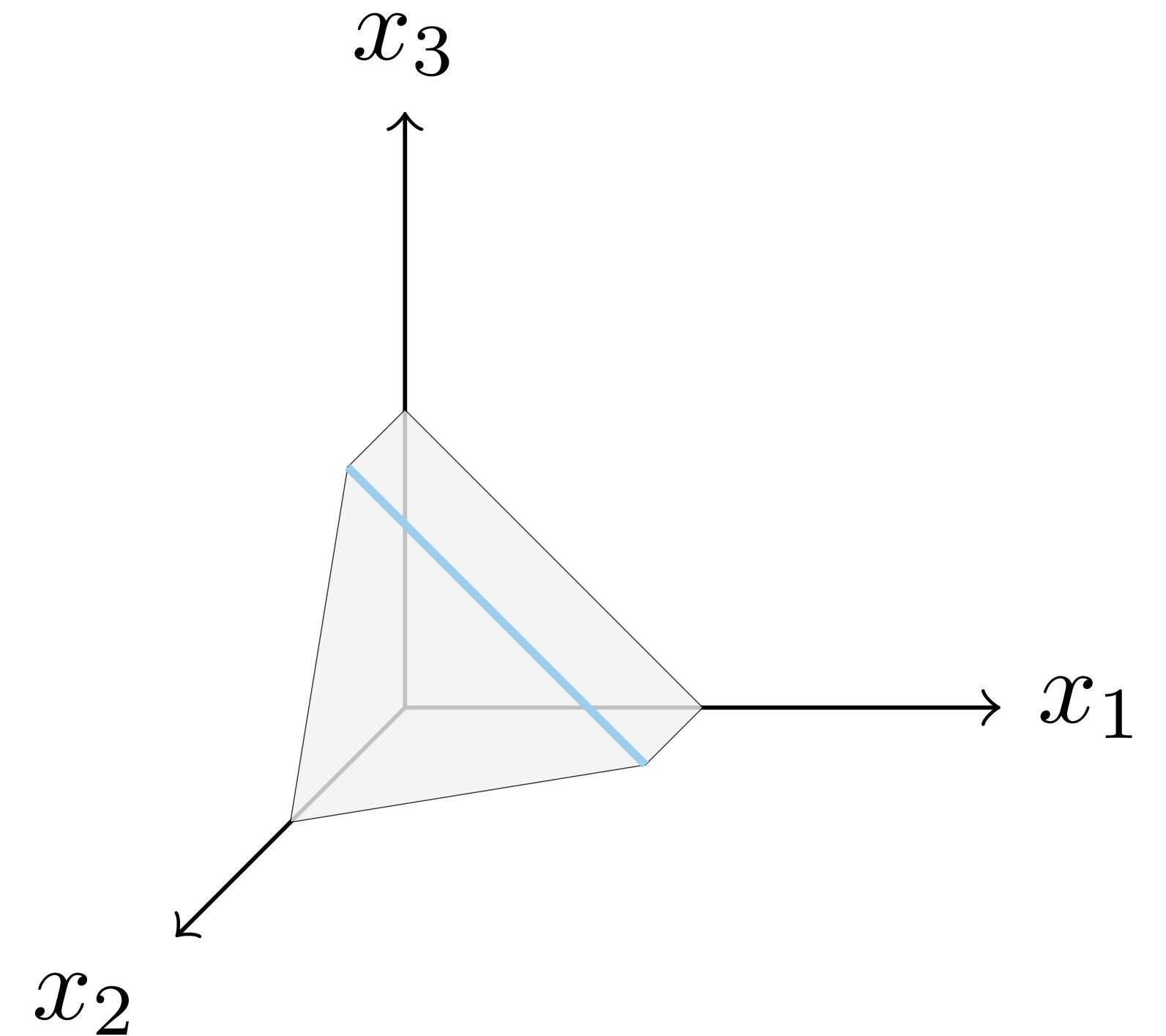

Set  $x_1 = 0$  and solve

$$\begin{bmatrix} 1 & 0 & 1 \\ 1/2 & 1 & 1/2 \end{bmatrix} \begin{bmatrix} x_1 \\ x_2 \\ x_3 \end{bmatrix} = \begin{bmatrix} 1 \\ 1 \end{bmatrix} \rightarrow \begin{bmatrix} 0 & 1 \\ 1 & 1/2 \end{bmatrix} \begin{bmatrix} x_2 \\ x_3 \end{bmatrix} = \begin{bmatrix} 1 \\ 1 \end{bmatrix} \rightarrow (x_2, x_3) = (0.5, 1)$$



# Basic solutions

## Standard form polyhedra

$$P = \{x \mid Ax = b, x \geq 0\} \quad \text{with} \quad A \in \mathbf{R}^{m \times n} \text{ has full row rank } m \leq n$$

$x$  is a **basic solution** if and only if

- $Ax = b$
- There exist indices  $B(1), \dots, B(m)$  such that
  - columns  $A_{B(1)}, \dots, A_{B(m)}$  are linearly independent
  - $x_i = 0$  for  $i \neq B(1), \dots, B(m)$

$x$  is a **basic feasible solution** if  $x$  is a **basic solution** and  $x \geq 0$

# Constructing basic solution

1. Choose any  $m$  independent columns of  $A$ :  $A_{B(1)}, \dots, A_{B(m)}$
2. Let  $x_i = 0$  for all  $i \neq B(1), \dots, B(m)$
3. Solve  $Ax = b$  for the remaining  $x_{B(1)}, \dots, x_{B(m)}$

Basis  
matrix

Basis columns

Basic variables

$$A_B = \left[ \begin{array}{c|c|c|c} | & | & & | \\ \hline A_{B(1)} & A_{B(2)} & \dots & A_{B(m)} \\ \hline | & | & & | \end{array} \right], \quad x_B = \begin{bmatrix} x_{B(1)} \\ \vdots \\ x_{B(m)} \end{bmatrix} \longrightarrow \text{Solve } A_B x_B = b$$

If  $x_B \geq 0$ , then  $x$  is a **basic feasible solution**

# Existence and optimality of extreme points

# Existence of extreme points

## Example

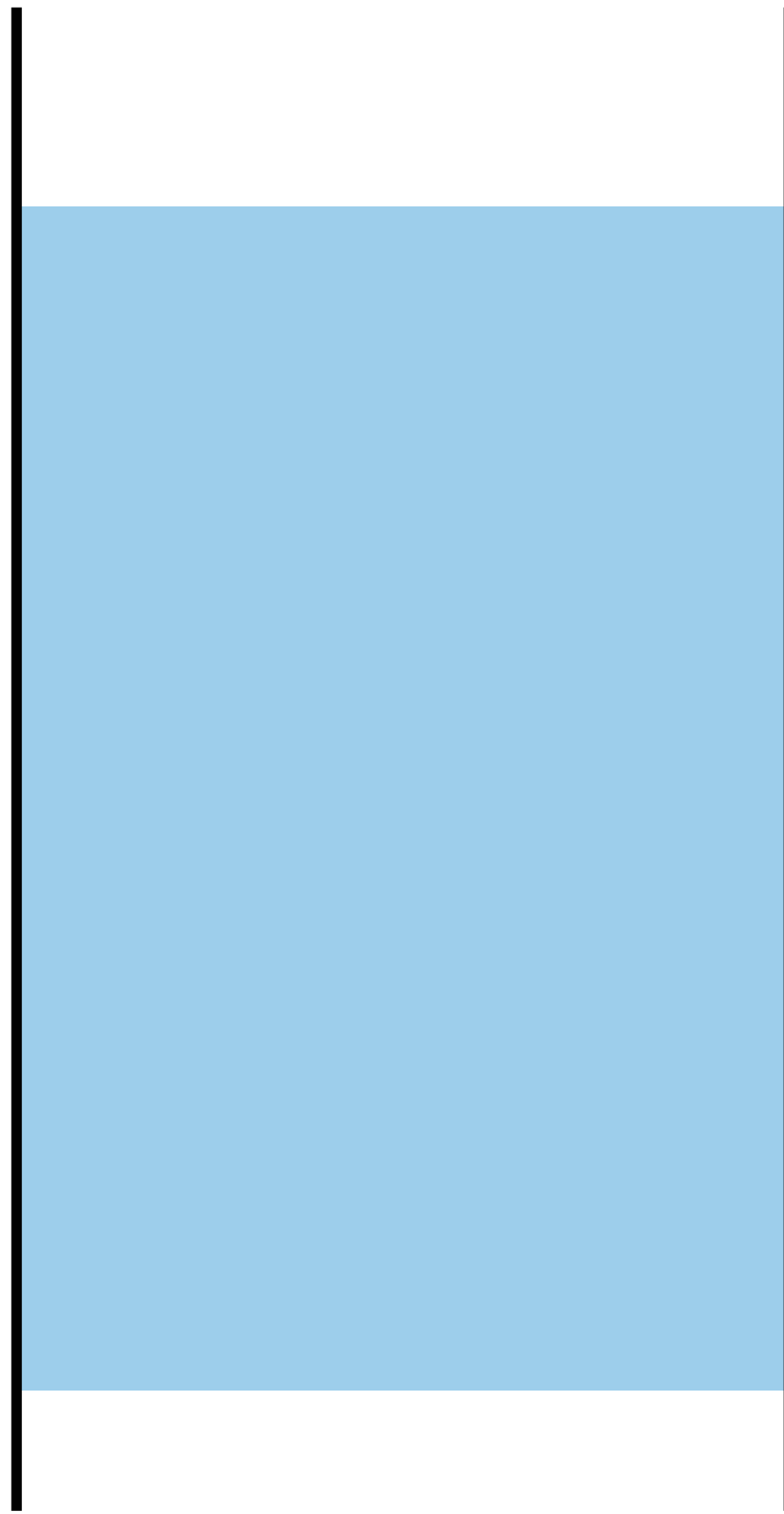

No extreme points

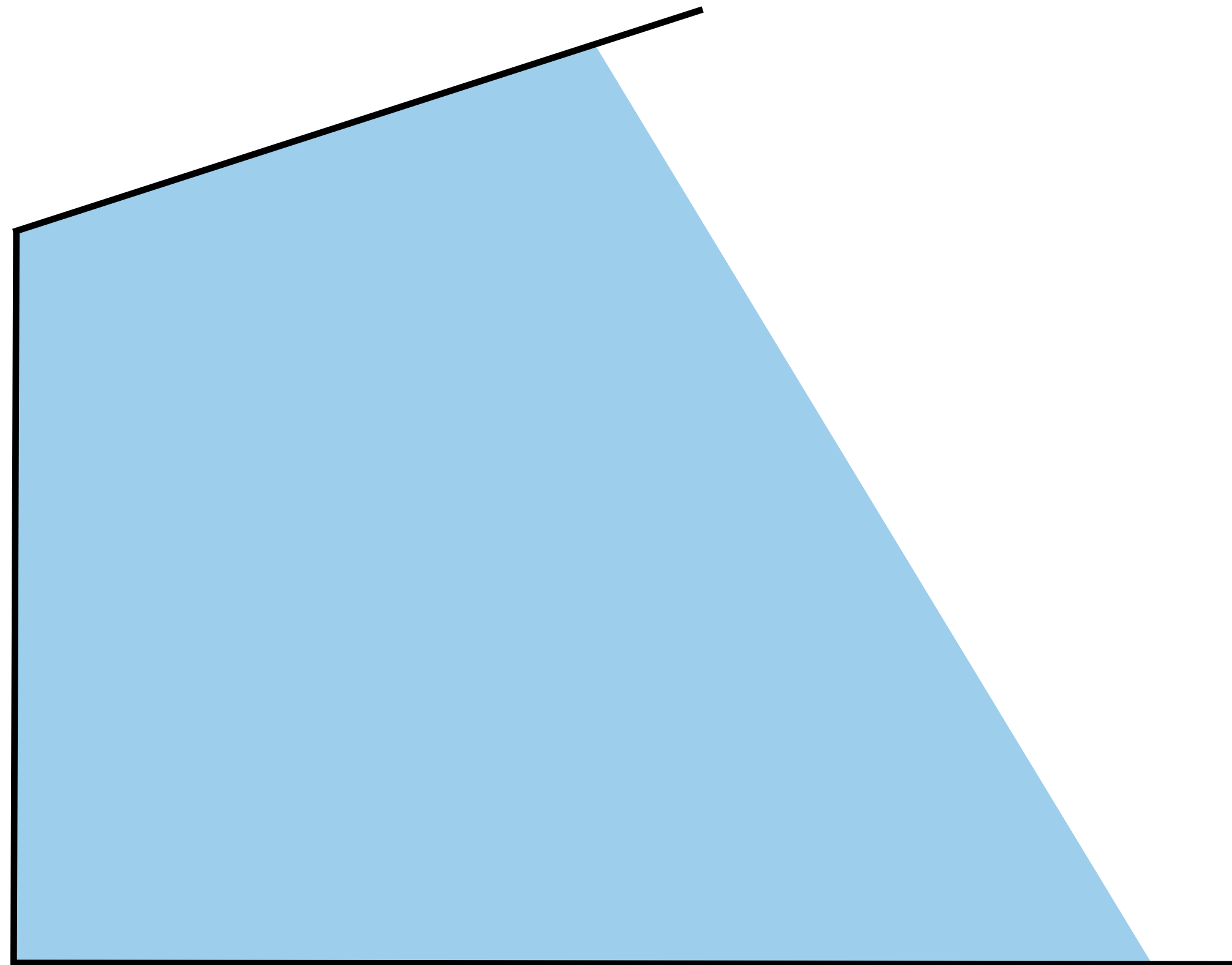

Extreme points

# Existence of extreme points

## Characterization

A polyhedron  $P$  **contains a line** if

$\exists x \in P$  and a nonzero vector  $d$  such that  $x + \lambda d \in P, \forall \lambda \in \mathbf{R}$ .

Given a polyhedron  $P = \{x \mid a_i^T x \leq b_i, \quad i = 1, \dots, m\}$ , the following are **equivalent**

- $P$  does not contain a line
- $P$  has at least one extreme point
- $n$  of the  $a_i$  vectors are linearly independent

## Corollary

Every nonempty **bounded polyhedron** has  
**at least one basic feasible solution**

# Optimality of extreme points

$$\begin{array}{ll} \text{minimize} & c^T x \\ \text{subject to} & Ax \leq b \end{array}$$

If

- $P$  has at least one extreme point
- There exists an optimal solution  $x^*$

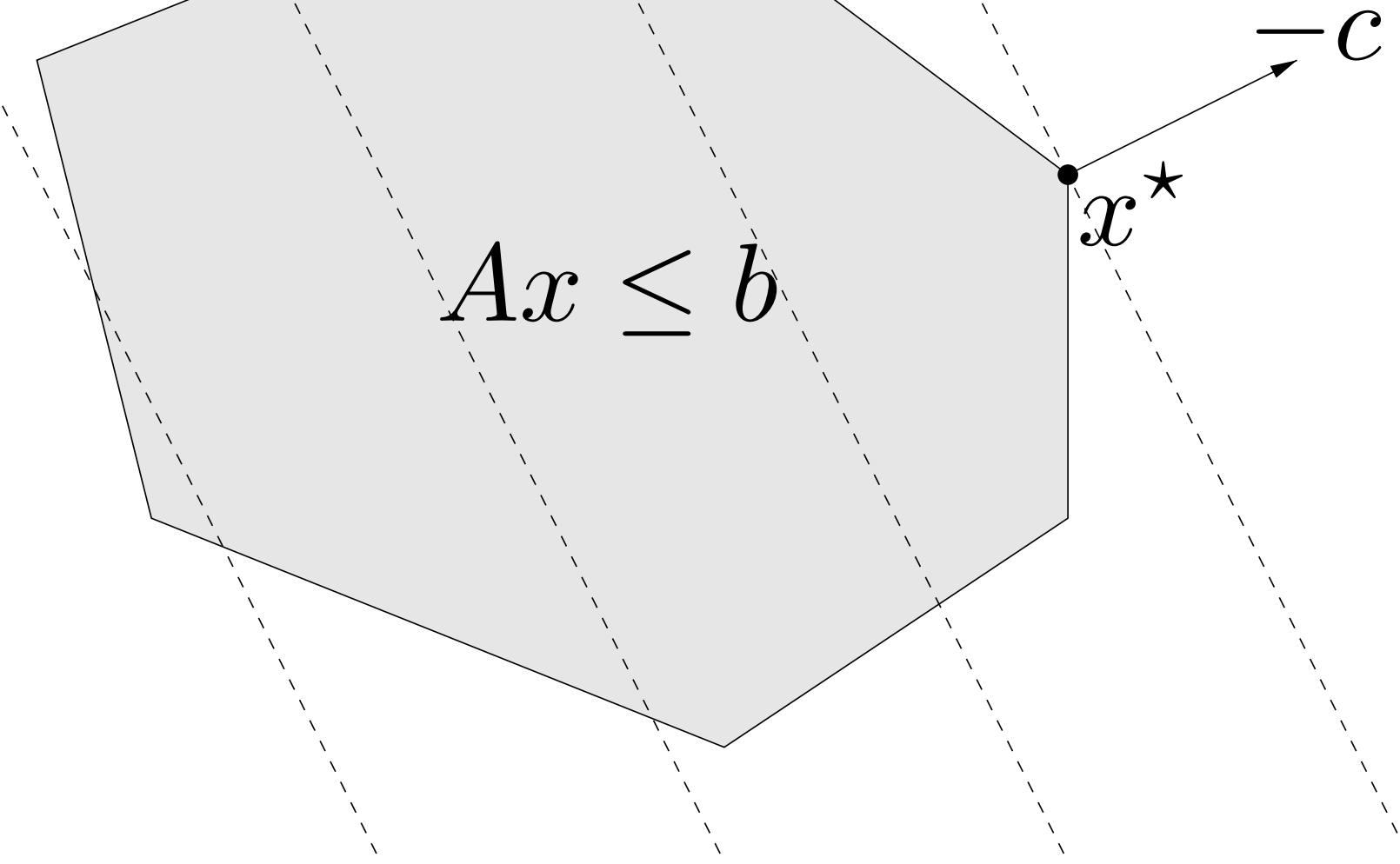

Then, there exists an optimal solution that is an **extreme point** of  $P$ .

Solution method: restrict search to **extreme points**.

# How to search among basic feasible solutions?

## Idea

List all the basic feasible solutions, compare objective values and pick the best one.

## Intractable!

If  $n = 1000$  and  $m = 100$ , we have  $10^{143}$  combinations!

# Conceptual algorithm

- Start at corner
- Visit neighboring corner that improves the objective

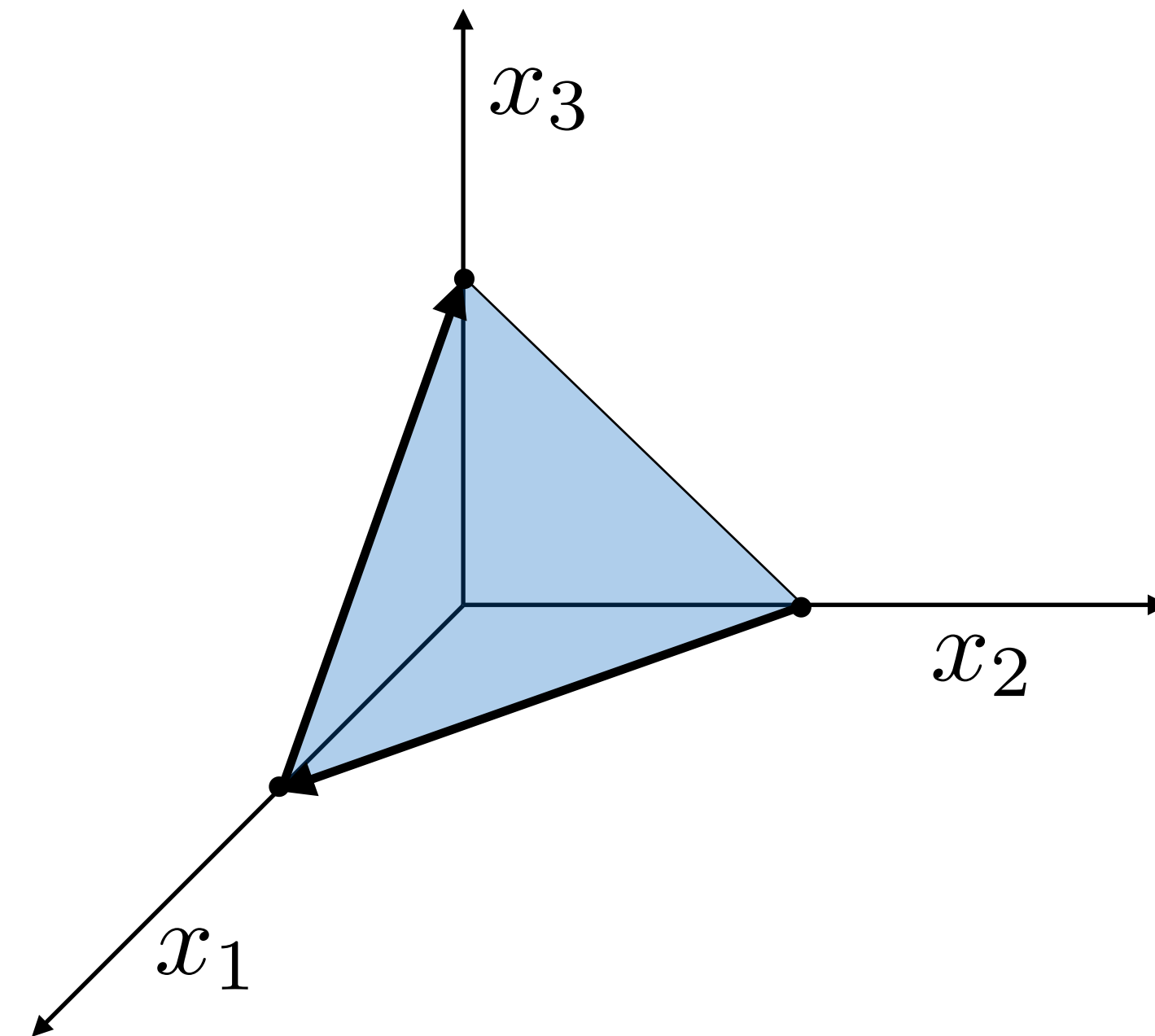



# Geometry of linear optimization

Today, we learned to:

- **Apply geometric and algebraic properties** of polyhedra to characterize the “corners” of the feasible region.
- **Construct basic feasible solutions** by solving a linear system.
- **Recognize existence and optimality** of extreme points.

# References

- Bertsimas and Tsitsiklis: Introduction to Linear Programming
  - Chapter 2.1 – 2.6 : geometry of linear programming

# Next topics

More applications

The simplex method